

DSL1 ECU

-

REFERENCE MANUAL

Baldur Gíslason

November 2, 2019

Contents

1	Introduction	3
2	Wiring	4
2.1	Pin-outs and description	4
2.1.1	Pin numbering	4
2.1.2	Connector A pin-out	5
2.1.3	Connector B pin-out	6
2.1.4	Connector C pin-out	6
2.1.5	Expansion board	6
2.2	Wiring diagram	9
2.3	Wiring guidelines	10
2.3.1	Grounding	10
2.3.2	12V feed	10
2.3.3	Fuel shut-off solenoid	10
2.3.4	Glow plugs	10
2.3.5	Engine speed sensor	11
2.3.6	Injection pump	11
2.3.7	Pedal position sensor	11
2.3.8	MAP sensor	12
2.3.9	Programmable outputs	12
2.4	Useful notes about the factory OM606 wiring harness	13

3	Software configuration	14
3.1	Theory of operation	14
3.2	Getting started	15
3.2.1	Engine speed sensor calibration	15
3.2.2	Pedal position sensor calibration	16
3.2.3	Rack position calibration	16
3.3	Performing firmware upgrades	16
4	Extended features	18
4.1	Cruise control	18
4.2	Speedometer output	19
4.3	OFGear 722.6 controller integration via CAN bus	19
4.3.1	DSL1 software configuration	19
4.3.2	Wiring	20
4.3.3	OFGear controller configuration	20
4.4	OBD2 communications	20
4.4.1	Wiring	21
4.5	Injection pump angle logging	21
A	Real time data fields	24
B	Error codes	25
C	1999 OM606 factory wiring diagram	28
D	DSL1 plug and play adaptor	31

1 Introduction

DSL1 is an engine management system for engines equipped with Bosch M-type EDC diesel injection pumps, such as Mercedes-Benz OM605/OM606. Also capable of controlling Bosch VP37 pumps as found on many Volkswagen/Audi applications as well as BMW and Mercedes Benz OM602.98x engines. To be able to run an engine, apart from the injection pump itself, two sensors are required. A throttle pedal position sensor and an engine speed sensor. Most applications will also use a manifold pressure sensor (MAP sensor) and if glow plug or fan control is required, then an engine coolant temperature sensor must be fitted. All of those sensors come standard on the OM605/606 turbo engines.

2 Wiring

2.1 Pin-outs and description

2.1.1 Pin numbering

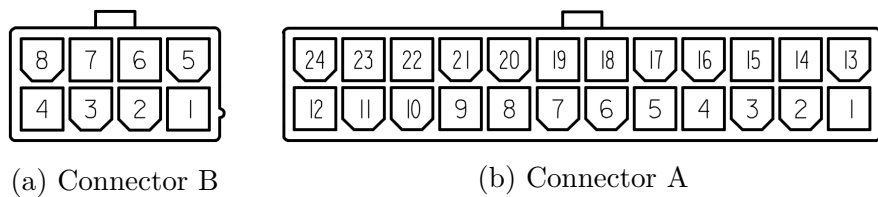

Figure 2.1: Connectors on the back of the controller and their pin numbering.

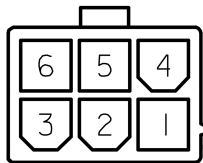

Figure 2.2: Connector C as found on controllers with serial numbers 200 and up, located between connectors A and B.

2.1.2 Connector A pin-out

Pin	I/O	Function	Note
1	OUT	5V supply for pedal position sensor	200mA max
2	IN	Analog 0 - Pedal position sensor primary	100k Ω pull-down
3	IN	Analog 1 - Pedal position sensor secondary	22k Ω pull-up
4	OUT	Ground return for pedal position sensor	
5	IN	Analog 4 0-5V	22k Ω pull-up
6	IN	Analog 5 0-5V	22k Ω pull-up
7	IO	CAN high	120 Ω termination on board
8	IO	CAN low	120 Ω termination on board
9	OUT	Output 1	Low-side switch, 3A max ² , 1k Ω pull-up to 12V
10	OUT	Output 2	Low-side switch, 3A max
11	IN	Power ground	
12	IN	Power ground	
13	OUT	5V supply for sensors	200mA max
14	IN	Analog 2 - Coolant temperature sensor	3k Ω pull-up
15	IN	Analog 3 - MAP sensor 0-5V	33k Ω pull-up
16	OUT	Ground return for sensors	
17	IN	Analog 6 0-5V	33k Ω pull-up
18	IN	Digital in 1	Only on S/N 200 and up. Active low, 12V tolerant. 4.7k Ω pull-up to 5V.
19	IN	Engine speed input VR or logic level	2.2k Ω pull-up
20	IN	Vehicle speed input VR or logic level	2.2k Ω pull-up until S/N 200. 4.7k Ω onwards.
21	OUT	Output 4	Low-side switch, 3A max
22	OUT	Output 3	Low-side switch, 3A max
23	IN	Switched +12V supply	
24	IN	Switched +12V supply	

²Hardware revision 4 (serial numbers 200 and onwards) can support up to 5A current on the programmable outputs. Combined current of all programmable outputs must not exceed 5A on older hardware or 10A on revision 4 with extra power ground

2.1.3 Connector B pin-out

Pin	I/O	Function	Note
1	OUT	Rack solenoid negative	IP brown/white wire - brown/white wires in OEM loom
2	OUT	Rack solenoid negative	IP brown/white wire - brown/white wires in OEM loom
3	IN	Rack position reference coil	IP green wire - white wire in OEM loom
4	IN	Rack position (actual value) coil	IP black wire - yellow wire in OEM loom
5	OUT	Rack solenoid positive	IP brown wire - red/blue in OEM loom
6	OUT	Rack solenoid positive	IP brown wire - red/blue in OEM loom
7	OUT	Sensor ground return	Shield if present
8	OUT	Sensor ground return	IP red wire - red in OEM loom

2.1.4 Connector C pin-out

Pin	I/O	Function	Note
1	IN	Power ground	Necessary if exceeding 5A combined current on all programmable outputs. Recommended in every case.
2	OUT	Output 5	Low-side switch, 5A max
3	OUT	Output 6	Low-side switch, 5A max
4	OUT	Glow relay comms	Dedicated pin for standard OM606 microcontroller glow plug relay (PWM communications). Built in pull-up.
5	OUT	Output 7	Low-side switch, 5A max, no PWM capability.
6	OUT	Output 8	Low-side switch, 5A max, no PWM capability.

2.1.5 Expansion board

In late 2019 an expansion board was introduced that is compatible with the later board revision (controller serial numbers 200 and up). The expansion board installs inside the case and adds a fourth connector on the back providing 8 additional analog inputs, 2 additional digital inputs and 4 additional switching outputs. As of firmware 1.29 these features are all visible in the configuration but perform no function unless the expansion board is installed.

pin connected.

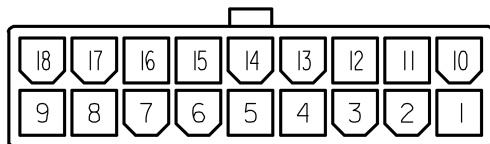

Figure 2.3: Connector D, note that it is installed upside down on the controller.

Pin	I/O	Function	Note
1	IN	Power ground	Join to wires connecting main ECU ground. Not necessary if not using outputs 9-12.
2	OUT	Output 9	Low-side switch, 5A max, no PWM capability.
3	OUT	Output 10	Low-side switch, 5A max, no PWM capability.
4	IN	Digital in 3	Active low, 12V tolerant. 10k Ω pull-up to 5V.
5	IN	Analog in 10	3k Ω pull-up
6	IN	Analog in 8	51k Ω pull-up
7	IN	Analog in 12	51k Ω pull-up
8	IN	Analog in 14	51k Ω pull-up
9	OUT	Sensor ground return	Do not connect to any other ground
10	IN	Power ground	Join to wires connecting main ECU ground. Not necessary if not using outputs 9-12.
11	OUT	Output 11	Low-side switch, 5A max, no PWM capability.
12	OUT	Output 12	Low-side switch, 5A max, no PWM capability.
13	IN	Digital in 2	Active low, 12V tolerant. 10k Ω pull-up to 5V.
14	IN	Analog in 11	51k Ω pull-up
15	IN	Analog in 9	51k Ω pull-up
16	IN	Analog in 13	51k Ω pull-up
17	IN	Analog in 15	51k Ω pull-up
18	OUT	5V supply for sensors	200mA max (shared with other 5V outputs)

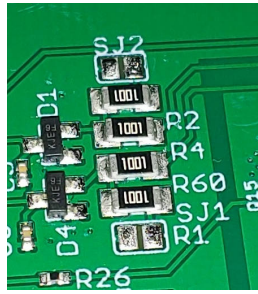

Figure 2.4: Solder jumpers on expansion board. Solder jumpers are the pads with no component mounted. SJ2 on top, SJ1 on bottom.

Digital inputs 2 and 3 can be configured for activation by a positive voltage instead of by grounding by the means of bridging solder jumpers on the expansion board. SJ1 pulls down input 3 and SJ2 pulls down input 2.

2.2 Wiring diagram

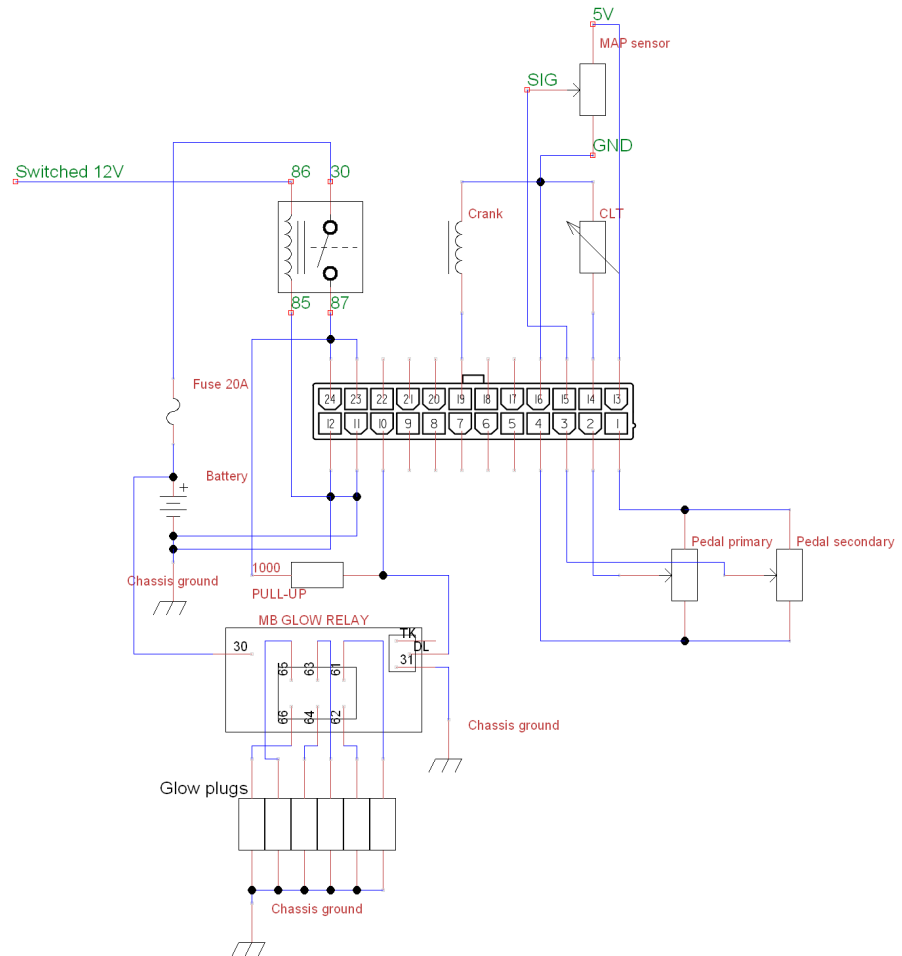

Figure 2.5: Typical basic wiring, not shown is the injection pump.

2.3 Wiring guidelines

2.3.1 Grounding

The controller should be connected to the battery negative terminal or another reliable grounding point by a pair of 1.5 mm² wires or a single 6 mm² wire joined to smaller wires near the connector. An improper ground connection will cause electrical noise and possibly faults with controller operation. If utilising factory Mercedes wiring, joining all of the supply ground wires for the Bosch ECU should suffice.

2.3.2 12V feed

The preferred method of feeding the controller is to keep the wiring from the battery positive terminal to the controller as short as possible to limit electrical noise and voltage drop. This is best done by routing a wire directly from the controller to the battery, with a 20A fuse and relay in line. If using factory Mercedes wiring, using factory fitted switched 12V feed via main relay should suffice but an extra relay must be fitted to switch the main relay negative.

2.3.3 Fuel shut-off solenoid

If your engine has a fuel shut off solenoid fitted (the little black box bolted to the inlet on the injection pump), connect that to 12V from the ignition switch or pin 6 of connector B on the ECU. The fuel temperature sensor is not utilised.

Pin	Wire colour	Function	Where connected
1	brown/white	FTS ground	not connected
2	brown	solenoid ground	any power ground
3	yellow/black	solenoid power	switched 12V source
4	blue/white	FTS signal	not connected

Figure 2.6: Fuel shut off solenoid wiring

2.3.4 Glow plugs

The ECU can control a glow plug relay, and as of firmware version 1.20 using the Mercedes EDC glow relay unmodified is now the preferred option.

The Mercedes relay has a few connections. An M6 stud that connects directly to the battery positive terminal. A big connector with 6 pins that connects to the glow plugs. The same relay fits 5 or 6 cylinder engines, 5 cylinder engines will just leave one pin unused.

Then there is a small connector with three pins. The pin terminals are labeled 31 for ground, DL for data link and TK which is not used. The ground wire is brown and the data link wire in the middle is usually white but sometimes uses other colours.

There must be a pull-up resistor valued between 1-10k Ω connecting the data link wire to a switched 12V source. The easiest way to accomplish this is to use programmable output 1 on the DSL1 (pin 9 of the 24 pin connector) which has a 1k pull up fitted internally so no external resistor is required.

If you wish to use the DSL1 to drive a petrol engine tachometer, you must use another output for the glow relay and thus must use a pull-up resistor.

To control the Mercedes glow relay, the output used must be configured for `PWM glow control` in the Calibrator software. If using a modified Mercedes relay or using any general purpose relay, select the `Glow control` setting for the output.

Units with serial number 200 and up have a dedicated output for the PWM glow relay, pin 4 of the 6 pin connector. This output has a built in pull-up and no configuration is necessary to enable it. Presently, no diagnostics are performed on the glow relay. If a glow indicator on the dashboard is desired to indicate when heating of the glow plugs is done, that must be taken from one of the wires leading to the glow plugs.

Control of the Mercedes glow relay is only precise to the nearest second or so. If heating time of less than 1 second is specified the relay may not turn on at all.

2.3.5 Engine speed sensor

The factory OM605/OM606 crank speed sensor is preferred but may not be an option on engines converted from mechanical to EDC. An alternative is to fit a hall effect sensor (1GT101 or GS100102 for example) to read the TDC stud located on the front of the crankshaft harmonic damper (may not work if the damper has any other features the sensor may pick up, such as notches cut). A sensor reading the starter ring gear can also be used. Having more than one tooth per engine rotation is preferable for idle control and anti stall performance with a manual transmission.

2.3.6 Injection pump

The injection pump has a single connector bringing out all of its features. Refer to connector B pin-out for wiring information. Power is supplied to the rack solenoid through an internal relay in the ECU, this is for safety reasons, enabling the ECU to cut power to the injection pump in case of component failure. The rack control solenoid draws high current. It is highly recommended that all four pins provided to supply the solenoid from connector B are used.

2.3.7 Pedal position sensor

The ECU can utilise either single potentiometer with idle switch as found on most older electronically controlled diesels (including Mercedes OM60x) as well as dual potentiometer and solid state units.

PPS pin	Wire colour	Function	ECU pin
1	blue/green	primary 5V feed	1
2	brown	secondary ground	4 or chassis ground as in OEM
3	blue/grey	secondary 5V feed	1
4	violet/yellow	secondary signal	3
5	violet/green	primary signal	2
6	blue	primary ground	4

Figure 2.7: Wiring for Mercedes W210 OM60x diesel accelerator pedal position sensor. Round body, part number A0115428617

PPS pin	Wire colour	Function	ECU pin
1	blue/brown	5V feed	1
2		no connection	
3	brown/white	sensor ground	4
4	violet/yellow	secondary signal	3
5	violet/green	primary signal	2
6	brown/yellow	sensor ground	4

Figure 2.8: Wiring for Mercedes W210 petrol engine or common rail accelerator pedal position sensor, part number A0125423317 and others. Also found on other chassis.

2.3.8 MAP sensor

If using the standard W210 MAP sensor, the table below describes its wiring, two different colour schemes are known but pin numbers are the same. Sometimes the pins are labeled inside the connector of the sensor, with V for 5V input, G for sensor ground and O for signal output.

MAP pin	Wire colour	Function	ECU pin
1	blue/red or grey/violet	signal	15
2	brown/white or brown/yellow	sensor ground	16
3	blue/black or white/black	+5V feed	13

If using a 4 bar GM style MAP sensor such as the one sold in the web shop, the table below describes its wiring:

MAP pin	Function	ECU pin
A	sensor ground	16
B	signal	15
C	+5V feed	13

2.3.9 Programmable outputs

The ECU has four programmable outputs and while all low speed functions are applicable to every output, some PWM functions have dedicated outputs. This means that if those functions are used, they can only be

assigned to the specified output. Firmware version 1.15 reduces the number of dedicated function assignments to only two. The rest of the functions can be freely assigned to any output. The outputs are low-side switches meaning the negative terminal of whatever device that is to be switched on is wired to the controller. The outputs are rated for 3A continuous current so anything that draws more current (Has a resistance smaller than 4.5Ω) must be wired through a relay.

Function	Output
Tachometer output	1
Speedometer output	2

Figure 2.9: Functions with dedicated outputs

2.4 Useful notes about the factory OM606 wiring harness

Most of the sensors on the engine (all except the MAP sensor) are brought out in a loom that runs underneath the intake manifold and terminates in a green connector. Alongside the green connector is a medium sized purple wire. The purple wire is the control signal that goes to the starter solenoid. The wires coming out of the green connector are as follows:

Pin	Wire colour	Function	Connects where
2	brown/black	Oil level sensor	Not used
3	brown	Fuel shut off solenoid ground	Any power ground
4	yellow/black	Fuel shut off solenoid positive	Switched 12V source
5	brown/white	Sensor ground	DSL1 conn A pin 16
6	green/red	Coolant temperature sensor	DSL1 conn A pin 14
7	green/white	Air temperature sensor	Not used
8	blue/white	Fuel temperature sensor	Not used
12	clear	Engine speed sensor ground	DSL1 conn A pin 16
13	green	Engine speed sensor	DSL1 conn A pin 19

Figure 2.10: Green connector pin-out

Note that the engine speed sensor wire is green, housed inside a shield, covered by black isolation.

3 Software configuration

Refer to [BG calibrator manual](#) for introduction to the PC application.

3.1 Theory of operation

The injection metering rack position is determined by monitoring the inductance of the two coils in the rack position sensors and comparing their values. The rack position does not have a unit of measure. **Rack control parameters** -> **Rack position request** is the transfer function that converts a requested injection amount into a target rack position. Its calibration does not have to reflect the actual metered fuel quantity but for good idle control, reasonable linearity at small injection amounts helps.

The base fuel injection quantity, in cc per 1000 events as is tradition with diesel pump evaluation, is set by the **Fuel request table** as a function of engine speed and throttle pedal position. The **Fuel limit table** is applied on top of that result to limit the injection quantity if charge air pressure (boost) is low. If using the unit to control turbocharger pressure, the requested fuel injection quantity (ignoring the limit table) is used as an input to the **Boost target table**. The metering rack is controlled by a PID feedback loop. The P in the PID is proportional and provides quick response. Too much P gain causes rapid oscillations when the target position is reached. The oscillations can be dampened by the D factor which is a derivative of the rack position and counters quick movements. Fine control is done by the I factor, the integrator. Too little integrator gain can cause slow oscillations as the control won't react fast enough when over/under target.

The controller is supplied with a reasonable set of default settings off a running engine, but some fine tuning may be necessary, especially of the **Rack position request** function as there are some variations in rack position sensor feedback between different pumps which are not perfectly compensated for by the rack position sensor control. Manual transmission cars require more attention in this area for good drivability than cars equipped with automatic transmissions.

Engine idle is controlled by a second PID loop. Idle control is active when numbers in the fuel request table are lower than what's required for the engine to idle. It is therefore important that the fuel request table has small numbers in the idle region, but too small cause the engine to return to idle too quickly and it may stall. Too large and the engine won't return to idle at all. This has to be tuned with the engine fully warmed

up as a warm engine has much lower friction than a cold one and thus requires less fuel to idle. If the idle is hunting it helps to record a data log and observe the rackP, rackI, rackD, rackposition, rackrequest, idleP, idleI, idleD parameters in relation to engine speed over time to determine which parameters are leading the control. In general, a slowly hunting idle is caused by not enough P/I gain in either rack control or idle control, sometimes both. If tuning the parameters does not amend it, a hunting idle may also be an indication of poor injection pump condition. If the pump has too much friction the metering rack may need excessive feedback to move freely. This problem may in some cases be masked by lowering the rack PWM frequency to induce vibration and keep the rack moving.

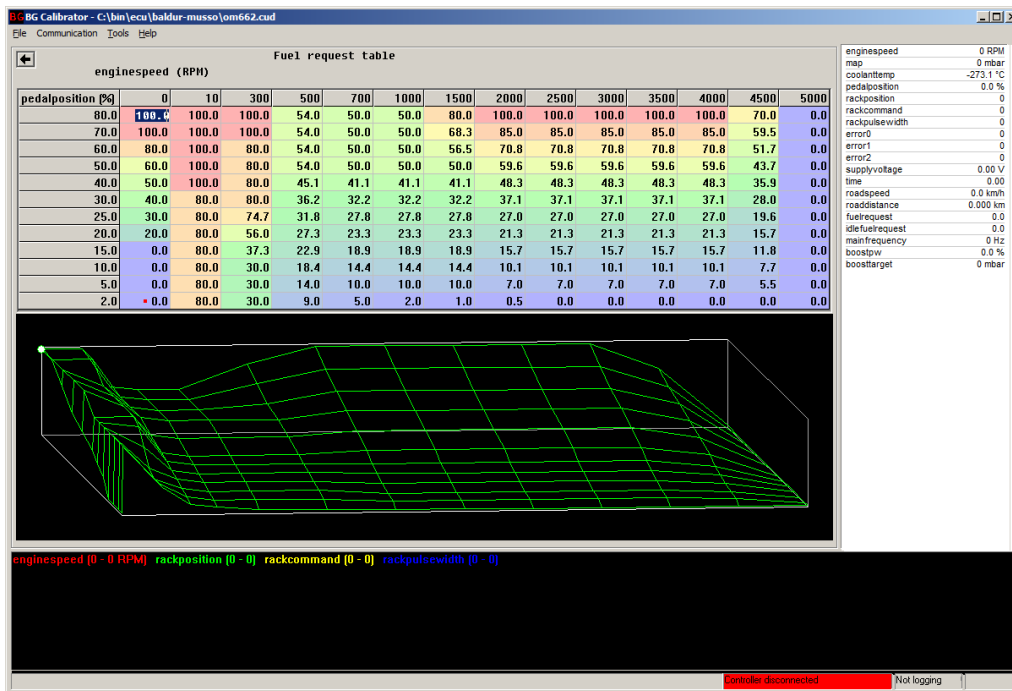

Figure 3.1: Fuel request table

3.2 Getting started

After you have wired up the controller and connected with the calibrator application, there are a number of things you must check before attempting to start the engine.

3.2.1 Engine speed sensor calibration

Select **Sensor inputs** -> **Frequency inputs**. If you have an OM605 engine with the stock 5 lug crank trigger, set the speed pulses per two rotations to 5 and pulse averaging to 1. If you have an OM606, use 6 pulses and 1 averaging. The way these settings work is that the ECU will ignore as many pulses as the averaging setting indicates before counting the next pulse. Effectively dividing the number of pulses actually seen by

$1+x$ where x is the averaging value. On the 605 for example, you have 10 pulses in two rotations but only 5 cylinders. It is counterproductive to take an engine speed reading more often than the number of cylinders so the divider is used to reduce the pulse count. Engine speed filter period should be set to a number smaller than the shortest possible pulse interval sent by the speed sensor. For an engine that sends 12 pulses across two rotations turning 8000RPM the shortest plausible interval is $1250\ \mu\text{s}$ so the default of $1000\ \mu\text{s}$ is a good choice for most installs.

3.2.2 Pedal position sensor calibration

Select `Sensor inputs` -> `Pedal/rack position inputs` -> `Pedal position voltage sensing range` and verify that with the pedal up the voltage of `analog0` is less than or equal to the left number in that table. Depress the pedal fully and verify that the voltage is equal or greater than the right number. Check that `error1` is zero and that the `pedalsecondary` is always greater than `pedalposition` across all of the pedal range, and that with the pedal up the `pedalsecondary` is at a lower value than it is when the pedal is depressed. If `error0` and `error1` are zero you are ready to start the engine.

3.2.3 Rack position calibration

This step is best done after engine has been warmed up. With the engine not running, depress the accelerator pedal to the floor and verify that `rackposition` roughly equals `rackcommand` and that `rackpulsewidth` does not continue to rise while the pedal is being held to the floor. If `rackpulsewidth` continues climbing but `rackposition` does not, you must reduce the maximum number in the `Rack control parameters` -> `Rack position request` function. If the pulse width is allowed to climb continually, rack solenoid overheating is possible during long periods of full throttle operation. Next thing to check is that the `idlefuelrequest` is no less than about $10\ \mu\text{L}/\text{event}$ after the engine has warmed up and engine is idling. If it is smaller, adjust the rack positions for small fuel quantities in the `Rack position request` function, lowering the numbers by maybe 20 units at a time until there is some headroom for the idle control to reduce fuel.

3.3 Performing firmware upgrades

Whenever new features are introduced, new firmware becomes available for download at <https://controls.is/firmware/>. See the release notes if you are unsure of whether you should update or not.

To perform a firmware upgrade:

1. Download firmware package from web site
2. Unzip firmware package into a directory on your hard drive

3. Connect USB cable between ECU and PC.
4. Power on ECU, do not start engine.
5. If you do not have the configuration backed up, run BG Calibrator, read configuration from ECU and save to file. This step may be skipped if you are performing the upgrade on an ECU you haven't made any previous configuration changes to.
6. Run `upgrade.cmd` in directory where firmware files are located.
7. Wait until the upgrade application finishes, should be on the order of 10 seconds.
8. Power ECU off.
9. Do not power ECU back on until you are ready to upload configuration to it.

The ECU has been upgraded but now contains the default configuration. If you are proceeding with default configuration, simply open the default configuration file for the new firmware in BG calibrator and go on-line. Otherwise, if you wish to retain your previous configuration, which is generally recommended, perform the following steps:

1. Run the BG Calibrator software
2. Open your old configuration file
3. Select `File -> Convert configuration` from the menu bar.
4. Select the configuration included with the new firmware in the file dialog.
5. The configuration has now been converted to the new format, save it and exit the Calibrator software.
6. Run the Calibrator software again and open the configuration file you saved previously, choose to work off-line.
7. Review the settings and verify that they make sense, see release notes for information about what settings may need revisiting.
8. Go on-line and power on the ECU. Do not start engine.
9. When prompted, select to use local settings, which will then be uploaded to the ECU.

After the configuration has been sent to the ECU and Calibrator application becomes responsive again, power the ECU off and then back on. Now you can start the engine.

4 Extended features

4.1 Cruise control

In order to use the cruise control, your controller must be using firmware version 1.6 or greater. The cruise control requires three switches wired multiplexed into analog input 5. The resume/accel switch goes via 22k Ω resistor to ground, the set/decel switch goes via 10k Ω resistor to ground and a cancel switch directly to ground with no added series resistance. For best results these switches should ground to or near the control unit. For cancel input, one should at least have a brake pedal switch (or relay actuated from the brake light circuit) but may also have others wired in parallel such as a clutch switch and/or hand operated cancel switch. For automatic transmission applications, a vehicle speed input is necessary for cruise control operation. For manual transmission applications it is recommended that the vehicle speed input is wired for safety reasons (blocking cruise control from engaging below a certain vehicle speed) but not strictly necessary. If a visual indicator is desired when the cruise control is active, use one of the general purpose outputs and set a condition to turn on when `flag_cruise = 1`. Note that in firmware 1.9 and earlier, the accel switch functions as set and decel switch functions as resume. This was corrected in firmware version 1.10 to match tradition as per the auto industry. For smooth operation of the cruise control, the road speed signal must be reasonably clean. If you are seeing variations of several km/h indicated when holding a steady speed you may be able to correct that using the VSS smoothing and pulse averaging functions.

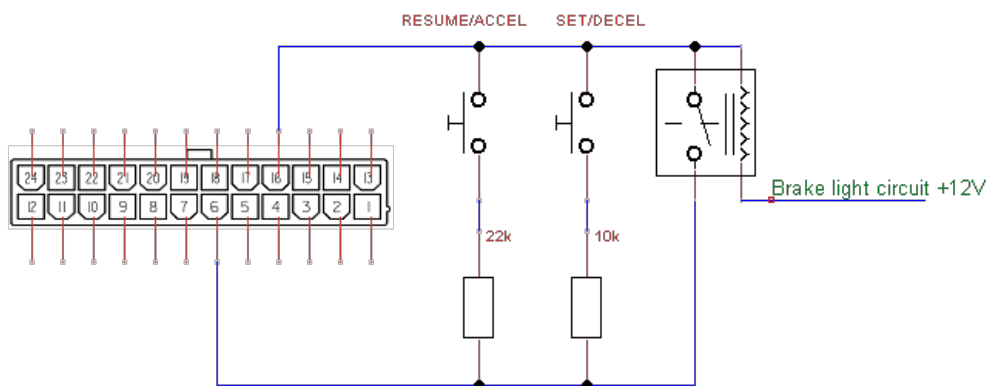

Figure 4.1: Typical cruise control switch wiring

The cruise control has a number of outputs that are of interest in the real time data feed.

cruisethrottle Throttle input from cruise control function.

cruiseP, cruiseI, cruiseD Cruise control PID loop output.

flag_cruise Indicator that cruise control is active.

cruisewitch State indicator for cruise control switches.

Value	Description
0	No switch active
1	Stop switch active
2	Set/decel switch active
3	Resume/accel switch active

4.2 Speedometer output

The DSL1 can as of firmware version 1.10 output a square wave signal to control a speedometer on output 2. This can be used to calibrate the speedometer in case the car has been fitted with different tyres or gear ratios. To use this function, select speedometer output as the function for output 2, write to flash and power cycle the controller. Then to calibrate, enter a speed to indicate in **General purpose outputs -> Speedometer output test speed** and adjust the value of **Speedometer output pulses per kilometre** until the speed indicated on the speedometer matches the configured test value. Set the test speed to zero when done. If the speedometer behaves strange when at full throttle, it may be necessary to rewire the speedometer and possibly the vehicle speed sensor, best noise performance is expected when each of those is grounded to the DSL1 sensor ground.

4.3 OFGear 722.6 controller integration via CAN bus

It is possible to send throttle position, engine speed and boost pressure to a transmission controller using the CAN bus, removing the need for the transmission controller to have its own sensors for those parameters. This section describes the necessary steps to make this integration work. For this option to work it is necessary that the OFGear controller has an OLED screen and not an LCD screen. It is also necessary that the OFGear controller has firmware version 186 or newer, and if it came with older firmware it may need a hardware modification performed by OFGear to bring it up to newest spec.

4.3.1 DSL1 software configuration

If your controller is sold with firmware 1.14 or later (July 2017), the necessary CAN configuration is already present in the default software

configuration. If your controller is older, you will need to apply the configuration. To make this easy a preset is provided. Select **Tools -> Configuration presets** from the menu at the top of the screen in the Calibrator application. In the CAN bus section of the dialog presented, double click 722.6 controller integration and press OK. Now you have successfully applied the necessary settings for the CAN broadcast. Power off the ECU and power it back on to activate the CAN bus data rate setting.

4.3.2 Wiring

The CAN bus consists of two wires, preferably twisted together. The CAN-H signal which is found on pin 7 of the 24 pin connector on the DSL1 connects to pin 2 of the 10 pin connector supplied with the OFGear controller. The CAN-L signal which is found on pin 8 of the 24 pin connector on the DSL1 goes to pin 1 of the 10 pin connector on the OFGear controller. Near the end of the bus which is furthest away from the DSL1 controller, which would be the OFGear end if there are no other devices on the bus, it is necessary to connect a termination resistor across the two wires. The resistor must have a value of 120 ohms.

4.3.3 OFGear controller configuration

To configure the OFGear controller for receiving TPS, engine speed and boost from DSL1, use the joystick and navigate to the right from the main screen until a page is shown titled CAN bus. Use the up/down motion of the joystick to set the CAN bus mode to OM606. No further configuration is necessary.

4.4 OBD2 communications

As of firmware version 1.16 it is possible to perform OBD2 over CAN bus communications with the DSL1. This enables the use of accessories that can display OBD2 data for instrumentation purposes (various OBD2 gauges, mobile phone applications and scan tools) as well as diagnostic trouble code readout. The protocol implemented is ISO15765-4 11 bit OBD over CAN.

To enable this functionality, the following configuration parameters must be set:

CAN bus data mode 500kbit

CAN receiving enable Enabled

OBD2 service enable Enabled

For diagnostic trouble codes, see Appendix B

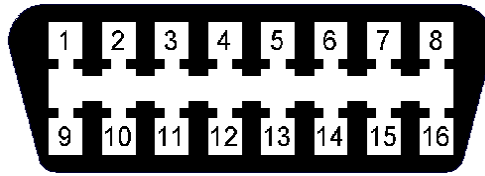

Figure 4.2: OBD2 female connector as seen from the end the scan tool plugs in to.

4.4.1 Wiring

The OBD2 connector has four essential connections. Pin 6 (CAN-H) connects to DSL1 24 pin connector pin 7. Pin 14 (CAN-L) connects to DSL1 24 pin connector pin 8. Pins 4 and 5 connect to ground (any chassis ground will do) and pin 16 connects to +12V. The standard specifies that the +12V should be taken through a fuse directly from the battery but most OBD2 devices will also perform correctly if the 12V source is switched. For correct operation it may be necessary to have a 120 ohm termination resistor connected across the CAN wires if there is none connected to the CAN bus already.

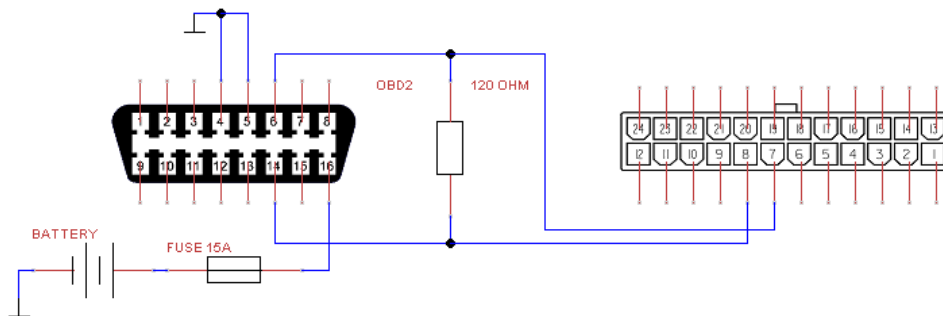

Figure 4.3: Typical wiring of OBD2 connector

4.5 Injection pump angle logging

As of firmware 1.18 it is possible to fit a sensor to the injection pump and log the behaviour of the pump timing device. To do this the vehicle speed input must be sacrificed, but vehicle speed can be received over CAN bus instead, either from a transmission controller or a general purpose CAN bus sensor interface such as <https://controls.is/mpc1.html>.

A prerequisite for the ability to log the pump angle is that the engine speed reference must have teeth spaced further apart than the range of the pump timing. This rules out the use of starter ring gear for engine speed but any method with less than 12 pulses per crankshaft rotation will work. Factory fitted OM605/OM606 trigger with 5 or 6 teeth is ideal. The `pumpangle` variable displays the pump timing in crankshaft degrees before the engine speed impulse, and is updated every time an engine

speed impulse is seen after a pump timing impulse is seen. Greater numbers are more advance. These numbers do not relate to top dead centre but the variation will illustrate the behaviour of the pump timing device as a function of engine speed and other parameters. The accuracy is reduced when crank acceleration/deceleration is very fast. (revving in neutral, shifting up, etc.)

The sensor known to work for this purpose is part number LCZ260 manufactured by Honeywell. The sensor body has a 3/8" UNF thread and fits inside the hole for the pump locking tool. The existing plug may be drilled and tapped. When installing the sensor, turn the engine until the pump timing mark shows, then thread in the sensor until the sensor bottoms out against the pump timing mark and back off about one and one quarter turns. Then rotate the engine by hand two full rotations to verify that the sensor is not in interference with any feature of the pump which would destroy the pump if engine was cranked over by the starter motor.

Wire the sensor as follows:

Wire	Connection
Black	Sensor ground, DSL1 pin 16.
Red	Supply voltage, switched 12V supply.
White	Signal output, DSL1 pin 20.

Two items must be configured on the ECU configuration. First set **Road speed source** to any of the CAN sources, even if you do not plan to use it. Next enable **Use road speed input for pump angle instead**.

Some noise is present on pump angle signal due to the pick up of features on the pump cam other than the one locking tool pawl, but this is of little consequence. The best way to read this data is to use the histogram feature of the log viewer to average out the noise and generate a tabular display showing the angle as a function of engine speed and fuel quantity or throttle position as the injection pump has been observed to require more torque when injecting greater fuel quantities, affecting the operation of the centrifugal pump timing device.



Figure 4.4: Honeywell LCZ260 sensor installed in injection pump

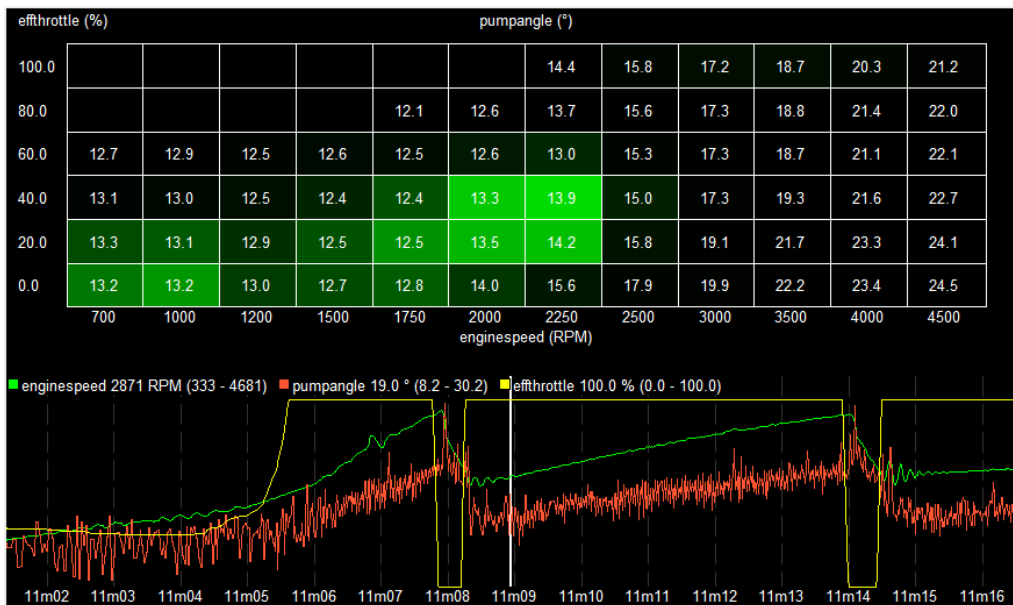

Figure 4.5: Pump angle analysis using histogram view in log viewer

A Real time data fields

As of firmware 1.18, the real time data fields are described in the configuration file. Hover the mouse over any variable in the right hand side real time variable display to see the description or open the real time display panel properties from the tools menu or by right clicking the real time variable display.

B Error codes

The error codes are stored on three bit masks, error0, error1 and error2, as described in the previous chapter. They can be read using the Calibrator application (Communication -> View controller errors in on-line mode, Tools -> Decode error variables in log view mode). It is also possible to read the errors using an OBD2 scan tool if OBD2 connector is wired and OBD2 communications are enabled in the configuration. OBD2 DTC codes take the form of P3XZZ where X is the error variable, 0 for error0 and so on and ZZ is the bit offset in that variable, starting with 00. Note that these codes do not correspond with any auto manufacturer's codes.

Errors that prohibit engine starting:

Value	Description
P3000	Primary rack position sensor high (open circuit)
P3001	Rack reference sensor high (open circuit)
P3002	Primary rack position sensor low (short to ground)
P3003	Rack reference sensor low (short to ground)
P3004	Rack position exceeding target position
P3011	Engine disabled due to test mode
P3012	Configuration error
P3013	Firmware crashed
P3014	Firmware crashed in interrupt mode
P3015	Firmware crashed in priority interrupt

Errors that let the engine start and idle but disable the accelerator pedal:

Value	Description
P3100	Throttle pedal voltage high
P3101	Throttle pedal voltage low
P3102	Throttle sensors disagree
P3103	Secondary throttle sensor out of range

Errors that will allow vehicle operation, but possibly at reduced performance:

Value	Description
P3200	MAP sensor voltage low
P3201	MAP sensor voltage high
P3202	Coolant temp sensor open circuit
P3203	Coolant temp sensor short circuit
P3204	Loss of CAN input data (one or more configured CAN data sources not receiving data)
P3205	Fuel pressure sensor low voltage (short to ground)
P3206	Fuel pressure sensor high voltage (open circuit)
P3207	Fuel feed pressure too low
P3208	Fuel feed pressure too high
P3209	Real Time Clock battery fault or no RTC battery fitted. Note that RTC is only used if controller fitted with internal data logging option.

C 1999 OM606 factory wiring diagram

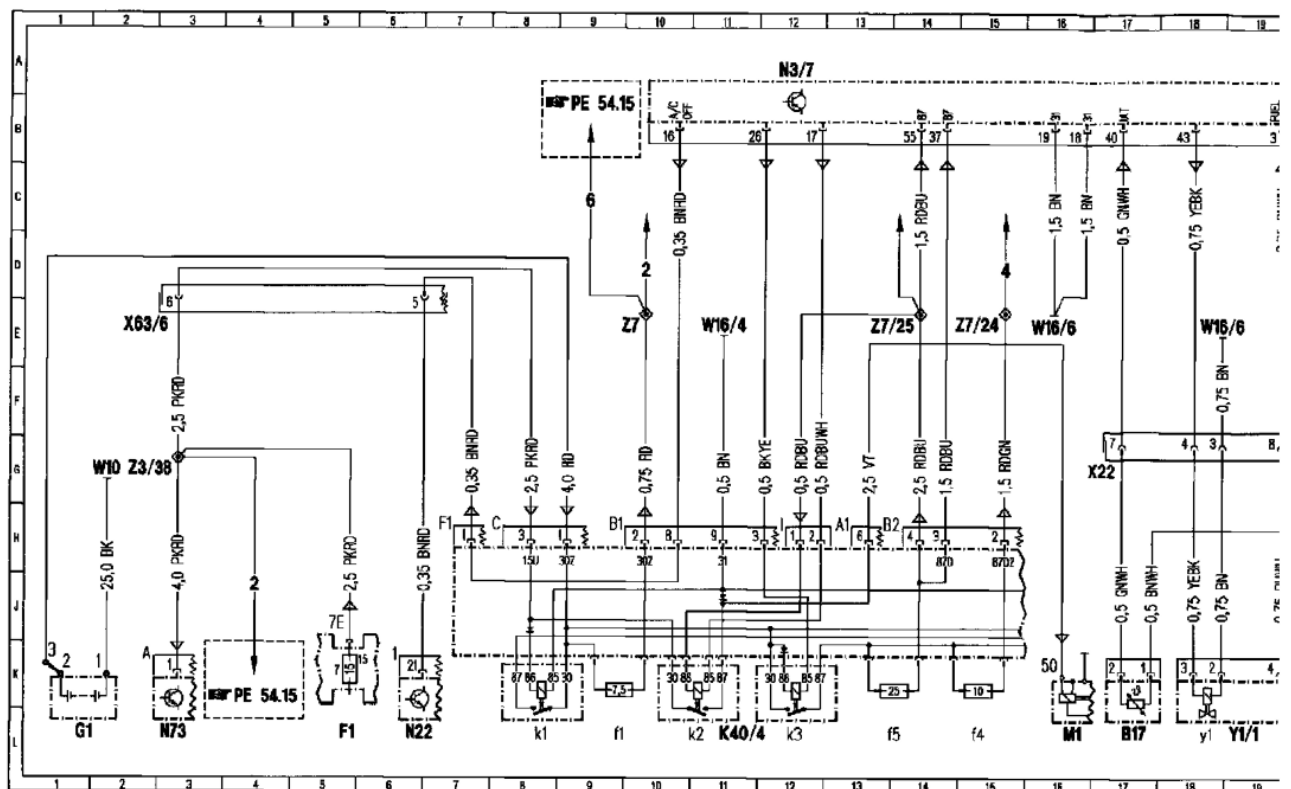

B2/5	Hot film MAF sensor	31L
B11	ECT sensor	21L
B17	IAT sensor	17L
B28	Pressure sensor	27L
F1	Fuse and relay box	5L
F1f7	Fuse 7	5K
G1	Battery	1L
K40/2	Driver-side fuse and relay module box	46L
K40/4	Passenger-side fuse and relay module box	11L
K40/4f1	Fuse, circuit 30z	9L
K40/4f4	Fuse 2, Motronic	14L
K40/4f5	Fuse 1, Motronic	13L
K40/4k1	Polarity protection relay	8L
K40/4k2	Starter relay	10L
K40/4k3	Relay module, AIR pump	12L
L5/6	CKP sensor (IFI/DFI)	23L
L5/6x1	CKP sensor connector (IFI/DFI)	22J
M1	Starter	16L

N3/7	Engine control module (IFI)	12A 20A 28A 36A 44A 52A
N14/2	Preglow control module	50L
N15/3	ETC control module	39L
N22	AAC pushbutton control module	6L
N73	Electronic ignition-starter switch (EIS) control module	3L 43L
R9	Glow plugs	49F
R25/2	IFI/DFI accelerator pedal position sensor	28L
R25/2r1	Reference potentiometer	28L
R25/2s1	CTP contact switch	28L
S40	CC pushbutton switch	41L
S40s1	Memory recall	42J
S40s2	Decelerate/set	42J
S40s3	Accelerate/set	42K
S40s4	Off	42K
S40s5	Control contact	42K

S40x1	CC pushbutton
S43	Oil level switch
W10	Ground (batte
W16/3	Ground (outpl
W16/4	Ground (outpl
W16/6	Ground (electr compartment
X11/4	Diagnostic tes
X11/22	Diagnostic mo connector
X12/3	Terminal bloc
X22	Engine compa
X25/7	Engine compa
X63/6	CAN-Bus/15u
Y1/1	IFI electrohydr
Y1/1b1	Fuel temperat
Y1/1y1	Actuator

C. 1999 OM606 factory wiring diagram

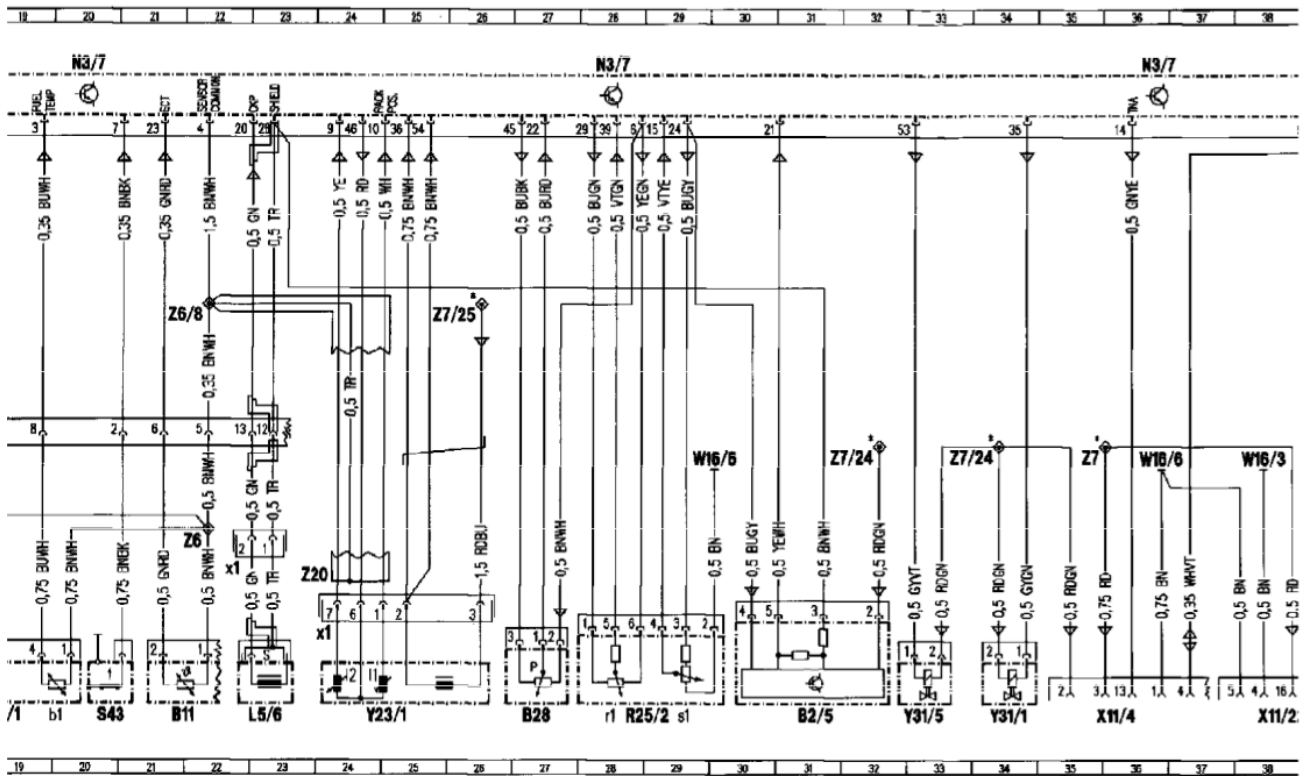

button switch connector	40H
switch	20L
battery)	2G
output ground-left wheel housing)	38G 48G
output ground - right wheel housing)	11E
electronics ground - component	16E
ent - right)	18E 29G 36G
c test clutch	35L
c module (OBD II) generic scan tool	38L
r	
block (circuit 30)	52G
mpartment/engine connector	16G
mpartment/FFS connector	39E 53E
/15u connector	2E
hydraulic shut-off actuator	19L
perature sensor	19L
	18L

Y23/1	Fuel quantity actuator (IFI)	24L
Y23/111	Fuel rack position sensor	24K
Y23/112	Regulating valve-actual value	24K
Y23/1x1	Fuel quantity actuator (IFI) connector	23K
Y31/1	EGR pressure transducer	34L
Y31/5	Boost pressure control/pressure control flap vacuum transducer	32L
Z3/30	Circuit 15 (unfused) connector sleeve	47G
Z3/38	Circuit 15 (unfused) connector sleeve	2G
Z6	Ground connector sleeve	21H
Z6/8	Sensor ground connector sleeve	21E
Z7	Circuit 30 connector sleeve	9E 35G
Z7/24	Circuit 87 connector sleeve	14E 31G 33G
Z7/25	Circuit 87 (unfused) connector sleeve (HF-M-SFI/base module)	13E 25E
Z8/3	ETC start lock connector sleeve	39G
Z20	Shielding placed inside insulated tubing	23J

Z37/2	Engine CAN-Bus (low) connector sleeve
Z37/3	Engine CAN-Bus (high) connector sleeve

C. 1999 OM606 factory wiring diagram

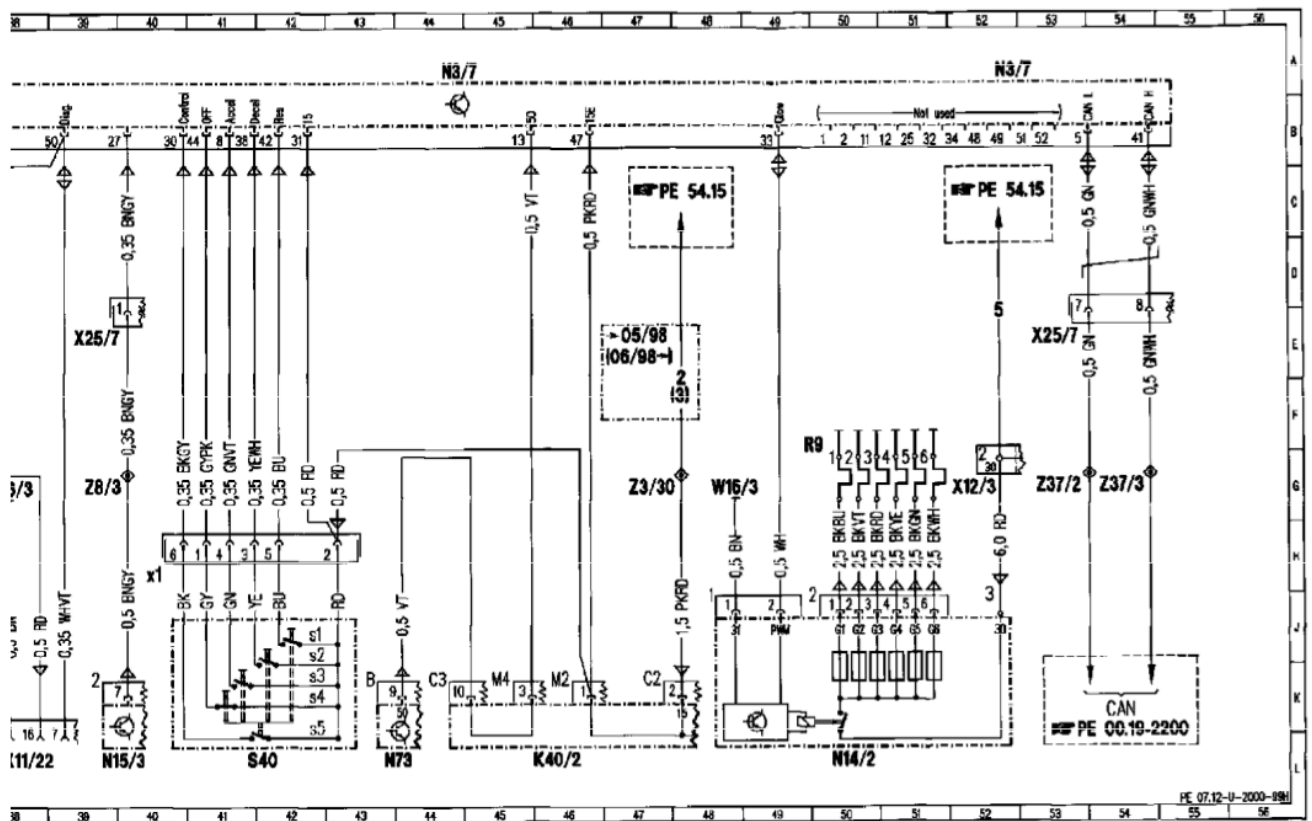

eve	53G
peve	54G

D DSL1 plug and play adaptor

Introduced in Q3 2019, the plug and play adaptor allows the use of a DSL1 ECU in a car that came with OM606 or OM605 engine as well as OM602.980 without modifying the car's wiring. Typical output configuration necessary to utilise the plug and play adaptor:

Output 1 55p pin 14. Normally unused. On older W202 cars without CAN bus instruments this pin is the tachometer output.

Output 2 55p pin 11. Normally unused. On some naturally aspirated cars this pin controls a valve in the intake manifold plenum.

Output 3 55p pin 52. Normally unused. On some naturally aspirated cars this pin controls a butterfly valve in the air intake.

Output 4 55p pin 49. Normally unused. On some older models with an automatic transmission that is not a 722.6, this pin controls a solenoid adjusting the transmission's line pressure.

Output 5 55p pin 53. Wastegate control solenoid.

Output 6 55p pin 34. Normally unused. On some older models with an automatic transmission that is not a 722.6, this pin controls the transmission's kick down solenoid.

Output 7 55p pin 43 but supplies positive voltage. Fuel shut off solenoid control.

Output 8 55p pin 17. Starter relay control. On some EIS equipped models the starter is engage by a CAN message. This pin may also be grounded by a positive voltage input on 55p pin 13.

Input function association when using the plug and play adaptor:

Analog in 4 55p pin 21. MAF sensor. Not typically used for anything but wired for sake of complete coverage.

Analog in 5 Cruise control circuit. Takes inputs from lots of pins on the 55pin header. What varies between models is how the brake pedal signal is brought in to the ECU.

Analog in 6 55p pin 40. Intake air temperature sensor. Not typically used for anything but wired for sake of complete coverage.

Digital in 1 55p pin 1. Needle lift sensor on OM602.98x engines. Unused on others. Note that an ECU with circuitry to deal with the low voltage needle lift signal is a special order item.

The following page contains a schematic showing the internal wiring of the plug and play adaptor. Part labeled X1 is the 55 pin header. Parts labeled X2 through X4 are the connectors on the DSL1.

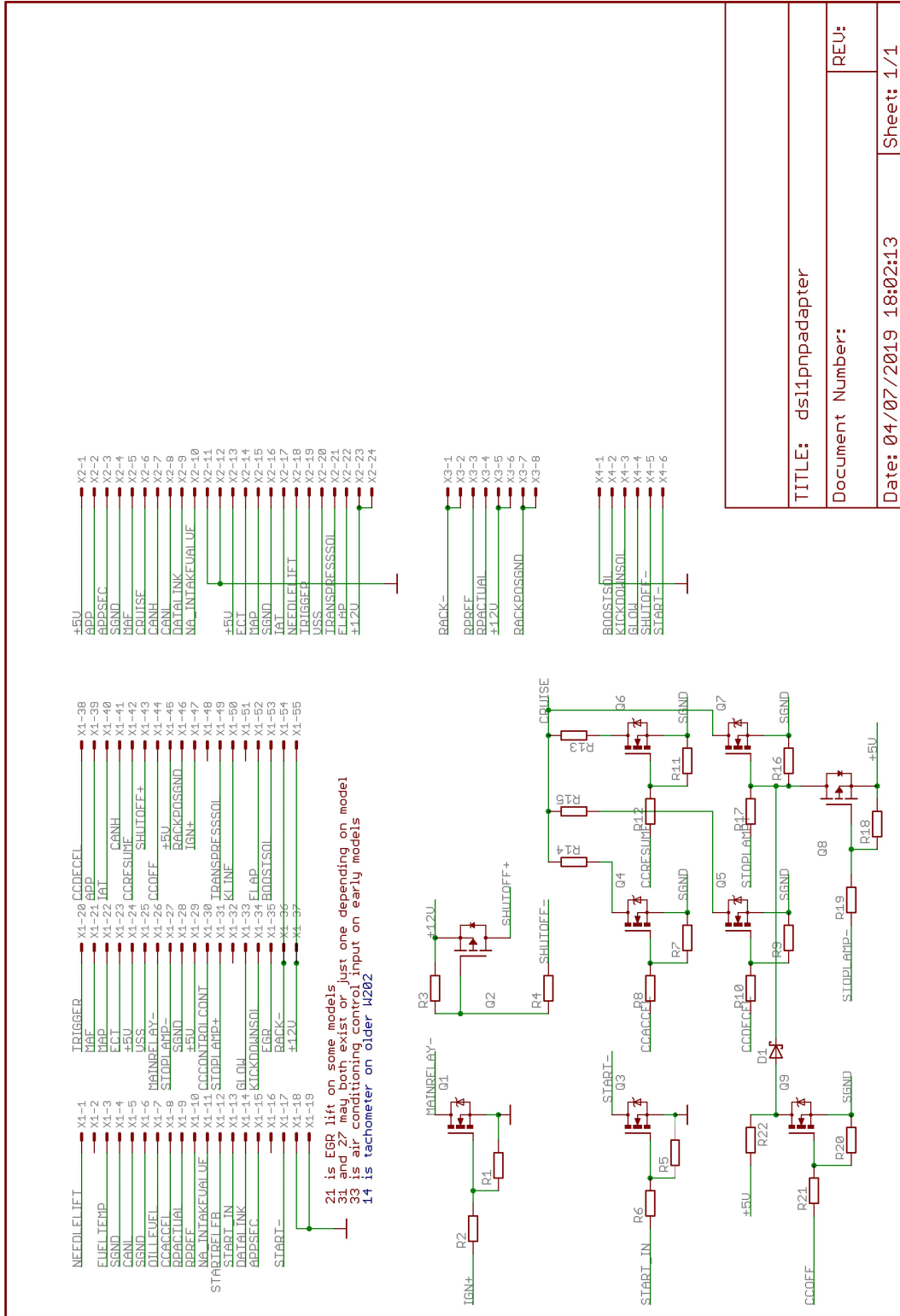

TITLE: ds11pnpadapater	
Document Number:	REU:
Date: 04/07/2019 18:02:13	Sheet: 1/1