

# DID1 ECU

-

## REFERENCE MANUAL

Baldur Gíslason

January 2, 2020

## Contents

1	Introduction	3
2	Wiring	5
2.1	Pin-outs and description . . . . .	5
2.1.1	Pin numbering . . . . .	5
2.1.2	Connector 1 pin-out . . . . .	5
2.1.3	Connector 2 pin-out . . . . .	5
2.1.4	Connector 3 pin-out . . . . .	5
2.1.5	Connector 4 pin-out . . . . .	7
2.1.6	Connector 5 pin-out . . . . .	8
2.2	Wiring diagram . . . . .	9
2.3	Wiring guidelines . . . . .	10
2.3.1	Plug and play Mercedes Benz configuration . . . . .	10
2.3.2	Grounding . . . . .	10
2.3.3	12V feed . . . . .	10
2.3.4	Injectors . . . . .	11
2.3.5	Switching and PWM outputs . . . . .	11
2.3.6	Glow plugs . . . . .	11
2.3.7	MAP sensor . . . . .	12
2.3.8	Rail pressure sensor . . . . .	12
2.3.9	Temperature sensors . . . . .	12
2.3.10	Crank and cam position sensors . . . . .	12
2.3.11	Pedal position sensor . . . . .	13

---

3	Software configuration	14
3.1	Getting started . . . . .	14
3.2	Performing firmware upgrades . . . . .	15
4	Extended features	17
4.1	Cruise control . . . . .	17
4.2	OBD2 communications . . . . .	18
4.2.1	Wiring . . . . .	18
A	Error codes	19
B	W210 E320 CDI wiring diagram for reference (OM613 engine)	20
C	W210 E220 or E270 CDI wiring diagram for reference (OM611 or OM612 engine)	31
D	W163 ML270 CDI wiring diagram for reference (OM612 engine)	42
E	Mercedes Benz OM648 wiring	54

# 1 Introduction

DID1 is an engine control unit for common rail diesel engines with up to 8 cylinders equipped with solenoid injectors. It is also capable of driving unit injectors as well as some spill valve controlled injection pumps. The injector outputs have a programmable voltage boost to shorten the current rise time as well as a programmable current limit profile. Injectors can open multiple times per firing cycle but no two injectors can be open simultaneously.

Notable hardware features:

**8 injector outputs** Software configurable boost voltage up to 100V. Software configurable peak current up to 32A and hold current up to 21A. Controllers ordered for plug-and-play operation with Mercedes Benz OM61x engines have only 6 injector outputs.

**11 configurable low-side switch outputs** 7 of which are PWM capable.

**14 0-5V analog inputs** 2 of which are dedicated for accelerator pedal input. Of the rest, 2 have 3000 $\Omega$  pull-up resistors for thermistor bias, a further 2 can be configured between 57.6k $\Omega$  and 3000 $\Omega$  and the rest have 57.6k $\Omega$  pull-ups.

**5 general purpose digital inputs** Not counting crank/cam sensor inputs. 4 of these are frequency capable. All are 12V tolerant but with 5V pull-ups. Inputs 1 and 2 have software configurable pull-down resistors so they can register positive voltage input.

**1 K-type thermocouple input** Measurable range 0 to 950 $^{\circ}$ C

**On board barometric pressure sensor**

**8 GB On board data logging memory** Capable of recording data at up to 1000Hz on selected channels or every channel at up to 500Hz.

**2 CAN 2.0B interfaces** Capable of sending and receiving arbitrary data as well as serve OBD2 over CAN. Data rates configurable up to 1Mbps.

**LIN bus interface** For control of turbocharger actuators and other devices relying on LIN networking.

**1 Analog output** 0-5V mappable to perform any function, perfect to provide a throttle or engine torque signal to transmission controllers or other devices not CAN-enabled.

## USB 2.0 for PC communication

## 2 Wiring

### 2.1 Pin-outs and description

#### 2.1.1 Pin numbering

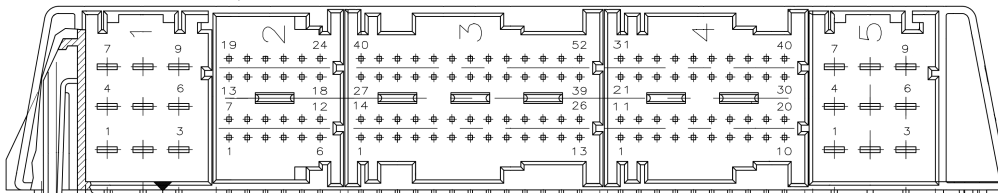

Figure 2.1: Connectors on the back of the controller and their pin numbering.

Below the function of each pin on the controller is listed. Any pins that have no internal connection are not listed.

#### 2.1.2 Connector 1 pin-out

Pin	I/O	Function	Note
1	IN	12V supply for peripherals	10A max
4	IN	Power ground	
5	IN	Power ground	
6	IN	Power ground	
7	IN	12V supply for ECU	15A max
8	IN	12V supply for ECU	15A max

#### 2.1.3 Connector 2 pin-out

Pin	I/O	Function	Note
11	IO	CAN 1 H	Internally terminated, also present on pin 3-1
12	IO	CAN 1 L	Internally terminated, also present on pin 3-2
13	IN	Main relay control in	+12V switched to ground main relay in Mercedes Benz PNP application

#### 2.1.4 Connector 3 pin-out

Pin	I/O	Function	Note
1	IO	CAN 1 H	Internally terminated, also present on pin 2-11
2	IO	CAN 1 L	Internally terminated, also present on pin 2-12
3	IO	CAN 2 H	Internally terminated
4	IO	CAN 2 L	Internally terminated
5	OUT	5V reference output	200mA max
6	IN	Thermo couple +	K-type
7	IN	Thermo couple -	K-type
8	OUT	Sensor ground	
9	IN	Analog input 1	Accelerator pedal secondary, 100k $\Omega$ pull down
10	IN	Analog input 0	Accelerator pedal primary, 57.6k $\Omega$ pull up
12	OUT	Output 9	Low-side switch, 5A max
14	IN	Analog input 8	57.6k $\Omega$ pull up
15	IN	Analog input 9	57.6k $\Omega$ pull up
16	IN	Analog input 10	57.6k $\Omega$ or 3k $\Omega$ pull up (software selectable)
17	IN	Analog input 11	57.6k $\Omega$ or 3k $\Omega$ pull up (software selectable)
18	OUT	5V reference output	200mA max
19	OUT	Sensor ground	
20	IN	Digital input 1	Active low, 12V tolerant, 10k pull up or 1k pull down software selectable
21	IN	Digital input 2	Active low, 12V tolerant, 10k pull up or 1k pull down software selectable. Not for frequency/speed input
22	IN	Digital input 3	Active low, 12V tolerant, 10k pull up
23	OUT	Sensor ground	
24	IN	Digital input 5	Active low, 12V tolerant, 10k pull up
25	OUT	Output 11	Low side switch, 1A max, 4.7k pull up to 12V
26	IN	Digital input 4	Active low, 12V tolerant, 10k pull up
27	IN	Analog input 12	57.6k $\Omega$ pull up
28	IN	Analog input 13	57.6k $\Omega$ pull up
29	IN	Analog input 14	57.6k $\Omega$ pull up
30	OUT	12V accessory output	5A max
35	OUT	12V accessory output	5A max
37	OUT	12V accessory output	5A max
40	OUT	5V reference output	200mA max

Pin	I/O	Function	Note
41	OUT	Sensor ground	
42	IO	LIN bus	Shared with pin 4-32. Not advisable to use both at same time.
43	OUT	Output 10	Low-side switch, 5A max
45	OUT	Analog output	0-5V out
46	OUT	Main relay out	Low-side switch, 1A max
48	OUT	Output 5	Low-side switch, 5A max
49	OUT	Output 1	Low-side switch, 5A max
50	OUT	Output 4	Low-side switch, 5A max, flyback diode for PWM
51	OUT	Output 7	Low-side switch, 5A max
52	OUT	Output 8	Low-side switch, 5A max

### 2.1.5 Connector 4 pin-out

Pin	I/O	Function	Note
1	OUT	5V reference output	200mA max
2	OUT	Sensor ground	
3	IN	Cam sync input	2.2k $\Omega$ pull-up, 12V tolerant. Hall effect or VR
4	OUT	Sensor ground	
6	IN	Analog input 6	MAP sensor input. 57.6k $\Omega$ pull-up
7	OUT	Sensor ground	
8	OUT	5V reference output	200mA max
10	OUT	Output 2	Low-side switch, 5A max
11	OUT	12V accessory output	5A max
12	OUT	5V reference output	200mA max
13	OUT	5V reference output	200mA max
14	IN	Analog input 4	Rail pressure sensor, 57.6k $\Omega$ pull-up
18	OUT	5V reference output	200mA max
21	OUT	Output 3	Low-side switch, 5A max, flyback diode to accessory 12V.
22	OUT	12V accessory output	5A max
23	IN	Analog input 3	Typically charge air temperature sensor. 3k $\Omega$ pull-up
24	IN	Analog input 5	57.6k $\Omega$ pull-up
25	OUT	12V accessory output	5A max
26	IN	Crank trigger input	2.2k $\Omega$ pull-up, 12V tolerant. Hall effect or VR
27	OUT	Sensor ground	
31	OUT	12V accessory output	5A max

Pin	I/O	Function	Note
32	IO	LIN bus	Shared with pin 3-42. Not advisable to use both at the same time.
33	OUT	Output 6	Low-side switch, 5A max
34	OUT	Sensor ground	
36	IN	Analog input 2	Typically coolant temperature sensor. 3k $\Omega$ pull-up
37	OUT	Sensor ground	

### 2.1.6 Connector 5 pin-out

Pin	I/O	Function	Note
1	OUT	Injector 8 negative	Injector supply common on ECUs configured for OM611/OM612/OM613 plug and play
2	OUT	Injector 7 negative	Injector supply common on ECUs configured for OM611/OM612/OM613 plug and play
3	OUT	Injector 6 negative	
4	OUT	Injector positive common	
5	OUT	Injector 1 negative	
6	OUT	Injector 4 negative	
7	OUT	Injector 3 negative	
8	OUT	Injector 2 negative	
9	OUT	Injector 5 negative	



## 2.2 Wiring diagram

Work in progress.

## 2.3 Wiring guidelines

### 2.3.1 Plug and play Mercedes Benz configuration

The controller is designed to be plug and play for Mercedes Benz OM611, OM612, OM613 engines. However due to some differences between the wiring of different chassis containing these engines some modifications to the car's wiring may need to be done. The controller is designed to be fully plug and play for a W210 E320 CDI, other cars may need modifications. In the case of the W163 ML270 CDI, W210 E220 CDI, W210 E270 CDI or other cars with OM611 or OM612 engines the following wires need to be moved around:

OEM pin	DID1 pin	Colour	Note
3-22	4-7	green	MAP sensor ground
3-17	4-8	red	MAP sensor +5V
3-6	4-6	orange	MAP sensor signal
3-31	3-37	blue	M class only: Electric fan +12V switched (may be substituted for other +12V accessory pin)
3-45	3-52	orange	M class only: Electric fan PWM control from switching output 8
3-1	4-27	blue	Sensor ground for charge air temperature sensor. May substitute other sensor ground pin or splice existing wire.
3-12	4-23	orange	Charge air temperature sensor to analog input 3
3-40	N/C	blue	Remove wire to avoid interfering with on board diagnostics
3-28	N/C	orange	Remove wire to avoid interfering with on board diagnostics

### 2.3.2 Grounding

The controller should be connected to the battery negative terminal or another reliable grounding point by a no less than three 1.5 mm<sup>2</sup> (14-16 AWG) wires running in parallel. Length of ground wires should be kept as short as practical. An improper ground connection will cause electrical noise and possibly faults with controller operation.

### 2.3.3 12V feed

The controller requires no less than two 1.5 mm<sup>2</sup> (14-16 AWG) running in parallel or a single 2.5 mm<sup>2</sup> (12 AWG) to the battery positive terminal through a fuse or circuit breaker and a relay. Power is to be fed into pins 7 and 8 of connector 1 and the circuit should be fused at 15-20A. Keep wiring as short as possible to limit electrical noise and voltage drop. A secondary supply for external accessories must also be wired for correct

operation. This supply goes to pin 1 of connector 1 and should be fused at 10A.

### 2.3.4 Injectors

If the ECU is ordered as a plug and play unit for Mercedes Benz OM61x engines there will be three pins providing positive voltage to the injectors. If the ECU is ordered in the 8 cylinder capable version it will have just one pin supplying positive voltage to the injectors and the other two pins become negative outputs for injectors 7 and 8.

For best performance the positive and negative wires for each injector should be twisted together all the way from the injector and the positive supply wires for the injectors should be joined close to the ECU. It is important to have very low resistance in the injector wiring so the wires should not be made longer than they need and they should use heavy gauge conductors. In any case no smaller than 1.5 mm<sup>2</sup> (14-16 AWG) as the resistance and inductance of these wires has an effect on the injectors ability to open quickly.

### 2.3.5 Switching and PWM outputs

The ECU has eleven programmable outputs and while all low speed functions are applicable to every output, some PWM functions have dedicated outputs. This means that if those functions are used, they can only be assigned to the specified output. The outputs are low-side switches meaning the negative terminal of whatever device that is to be switched on is wired to the controller. The outputs are rated for 3A continuous current and 5A intermittent with the exception of output 11 so anything that draws more current must be wired through a relay. All outputs except 3 and 4 have a 30 volt flyback voltage clamp built in but may need an external flyback diode for high current high frequency PWM operation.

Pins 4-21 (Output 3) and 3-50 (Output 4) have flyback current diodes restricting flyback voltage to supply voltage, making them suitable for continuous PWM operation of loads greater than 1A current and greater than 100Hz. This also makes them unsuitable for switching accessories that are live when the supply to the ECU is switched off. Outputs 1 and 11 have pull-up resistors so their connection to devices that have constant power should be evaluated first, the exception to this is something like the Mercedes Benz smart glow plug relay which does not pull the data line high by itself even though the glow relay is powered directly off the battery.

### 2.3.6 Glow plugs

The ECU can control any standard glow plug relay as well as Mercedes single wire smart glow relay. The glow plugs are normally controlled by output 11, pin 3-25. Note that this output pin is not rated for current greater than about 1A so make sure the relay being used does not have a

coil resistance of less than 12 ohms or use a different pin if this is not the case.

The Mercedes smart relay has a few connections. An M6 stud that connects directly to the battery positive terminal. A big connector with 6 pins that connects to the glow plugs. The same relay fits 4, 5 or 6 cylinder engines, 4 or 5 cylinder engines will just leave some pins unused.

Then there is a small connector with three pins. The pin terminals are labeled 31 for ground, DL for data link and TK which is not used. The ground wire is brown and the data link wire in the middle is usually white but sometimes uses other colours.

To control the Mercedes glow relay, the output used must be configured for `PWM glow control` in the Calibrator software. If using a modified Mercedes relay or using any general purpose relay, select the `Glow control` setting for the output.

Control of the Mercedes glow relay is only precise to the nearest second or so. If heating time of less than 1 second is specified the relay may not turn on at all.

The output used to control the Mercedes smart relay must have a 12V pull-up. The ECU has built in pull ups on outputs 1 and 11.

### 2.3.7 MAP sensor

The ECU expects the intake manifold absolute pressure sensor to be connected to input 6 (connector 4 pin 6). Typically the MAP sensor will also take 5V power from pin 4-8 and sensor ground from pin 4-7.

### 2.3.8 Rail pressure sensor

The fuel rail pressure sensor does not have a dedicated input but typical connection is analog input 4 (pin 4-14) with 5V supply taken from pin 4-13 and sensor ground at pin 4-4.

### 2.3.9 Temperature sensors

The temperature sensors do not have dedicated inputs but two analog inputs are provided that have a non-configurable 3 kilo ohm pull up resistor to them. Typical usage is to wire the coolant temperature sensor to analog input 2 (pin 4-36) and charge air temperature sensor to input 3 (pin 4-23) with sensor ground pins 4-27 and 4-34 used for return.

Analog inputs 10 (pin 3-16) and 11 (pin 3-17) have a software controllable 3 kilo ohm pull up associated with them so these can be used to connect thermistors as well.

### 2.3.10 Crank and cam position sensors

For the crank and cam position sensors, both variable reluctance and hall effect type sensors are supported.

The crank position sensor has a dedicated input on pin 4-26 and a sensor ground on pin 4-37. If using a hall effect sensor it will need a 5V supply, this would typically come from pin 4-1 or 4-12.

The cam position sensor has a dedicated input on pin 4-3 and typically uses sensor ground pin 4-2 and +5V supply from pin 4-12.

### 2.3.11 Pedal position sensor

The ECU can utilise either single potentiometer with idle switch as found on most older electronically controlled diesels (including Mercedes OM60x) as well as dual potentiometer and solid state units.

PPS pin	Wire colour	Function	ECU pin
1	blue/green	primary 5V feed	3-5
2	brown	secondary ground	3-23
3	blue/grey	secondary 5V feed	3-5
4	violet/yellow	secondary signal	3-9
5	violet/green	primary signal	3-10
6	blue	primary ground	3-8

Figure 2.2: Wiring for Mercedes W210 OM60x diesel accelerator pedal position sensor. Round body, part number A0115428617

PPS pin	Wire colour	Function	ECU pin
1	blue/brown	5V feed	3-5
2		no connection	
3	brown/white	sensor ground	3-23
4	violet/yellow	secondary signal	3-9
5	violet/green	primary signal	3-10
6	brown/yellow	sensor ground	3-8

Figure 2.3: Wiring for Mercedes W210 petrol engine or common rail accelerator pedal position sensor, part number A0125423317 and others. Also found on other chassis.

## 3 Software configuration

Refer to [BG calibrator manual](#) for introduction to the PC application.

### 3.1 Getting started

It is advised to leave the injectors disconnected until correct operation of rail pressure control, crank trigger and accelerator pedal has been verified. The default configuration has the configurable outputs all disabled to avoid conflict with different cars after firmware upgrade. It is advised to check for firmware updates from the web site prior to first start, see the next section for information.

Steps to perform before starting engine:

1. Check accelerator pedal operation. Verify that `app` variable reads less than 0.0% when the pedal is released and that it reacts to movement of the pedal.
2. Check that rail pressure reads close to 0 when engine is stopped on a common rail application. Applications without a rail pressure sensor (not common rail) should set the minimum rail pressure to allow starting to 0.0 bar in the Starting section of the configuration.
3. Check that temperature sensors are operating, check variables `airtemp` and `coolanttemp` read reasonable values and perform calibration if they do not. These temperature sensors are not absolutely essential to operation of the engine so if they read incorrectly that may be put aside to be solved after first start up.
4. Check that the correct number of cylinders, firing order and injector output assignment is configured. Some common engines are found in the configuration presets (found in the Tools menu at the top of the screen in Calibrator).
5. Configure the programmable outputs, the presets are a good starting point.
6. Verify correct operation of crank trigger. Run starter with injectors (connector 5) disconnected and verify that the Calibrator software displays engine speed as well as `syncstate` variable having a value of 7 after the starter has operated for a couple of seconds.

7. Verify correct operation of rail pressure control. This can be done at the same time as the previous step. Run the starter with no injectors connected and see that the `railpressure` variable climbs after starting for a while and then finally settles on a stable value that is not greater than the `railtarget` variable. If there is air in the fuel system it may take a minute of cranking before rail pressure is observed and controllable. This step does not apply to applications other than common rail engines.
8. Now is a good idea to record an event log while cranking the engine and verify that the firing order and injection timing looks correct. This is done from the logging menu at the top of the screen of the Calibrator software. The ECU must be connected and another data log must not be in progress to enable this option.
9. If problems are observed, rectify them before continuing. Contact technical support for advice if anything is not clear.
10. Connect injectors and attempt to start engine.

## 3.2 Performing firmware upgrades

Whenever new features are introduced, new firmware becomes available for download at <https://controls.is/firmware/>. See the release notes if you are unsure of whether you should update or not.

To perform a firmware upgrade:

1. Download firmware package from web site
2. Unzip firmware package into a directory on your hard drive
3. Connect USB cable between ECU and PC.
4. Power on ECU, do not start engine.
5. If you do not have the configuration backed up, run BG Calibrator, read configuration from ECU and save to file. This step may be skipped if you are performing the upgrade on an ECU you haven't made any previous configuration changes to.
6. Run `upgrade.cmd` in directory where firmware files are located.
7. Wait until the upgrade application finishes, should be on the order of 10 seconds.
8. Power ECU off.
9. Do not power ECU back on until you are ready to upload configuration to it.

The ECU has been upgraded but now contains the default configuration. If you are proceeding with default configuration, simply open the default configuration file for the new firmware in BG calibrator and go on-line. Otherwise, if you wish to retain your previous configuration, which is generally recommended, perform the following steps:

1. Run the BG Calibrator software
2. Open your old configuration file
3. Select **File -> Convert configuration** from the menu bar.
4. Select the configuration included with the new firmware in the file dialog.
5. The configuration has now been converted to the new format, save it and the Calibrator software will restart.
6. Review the settings and verify that they make sense, see release notes for information about what settings may need revisiting.
7. Go on-line and power on the ECU. Do not start engine.
8. When prompted, select to use local settings, which will then be uploaded to the ECU.

After the configuration has been sent to the ECU and Calibrator application becomes responsive again, power the ECU off and then back on. Now you can start the engine.



## 4 Extended features

### 4.1 Cruise control

The cruise control requires three switches wired multiplexed into any analog input through different value resistors to ground or alternatively from a CAN bus source. Typically the resume/accel switch goes via 22k $\Omega$  resistor to ground, the set/decel switch goes via 10k $\Omega$  resistor to ground and a cancel switch directly to ground with no added series resistance. For best results these switches should ground to a sensor ground on the controller. For cancel input, one should at least have a brake pedal switch (or relay actuated from the brake light circuit) but may also have others wired in parallel such as a clutch switch and/or hand operated cancel switch. For automatic transmission applications, a vehicle speed input is necessary for cruise control operation. For manual transmission applications it is recommended that the vehicle speed input is wired for safety reasons (blocking cruise control from engaging below a certain vehicle speed) but not strictly necessary. If a visual indicator is desired when the cruise control is active, use one of the general purpose outputs and set a condition to turn on when `flag_cruise = 1`. For smooth operation of the cruise control, the road speed signal must be reasonably clean. If you are seeing variations of several km/h indicated when holding a steady speed you may be able to correct that using the VSS smoothing and pulse averaging functions.

The cruise control has a number of outputs that are of interest in the real time data feed.

**cruisethrottle** Throttle input from cruise control function.

**cruiseP, cruiseI, cruiseD** Cruise control PID loop output.

**flag\_cruise** Indicator that cruise control is active.

**cruisewitch** State indicator for cruise control switches.

Value	Description
0	No switch active
1	Stop switch active
2	Set/decel switch active
3	Resume/accel switch active

## 4.2 OBD2 communications

It is possible to perform OBD2 over CAN bus communications with the ECU. This enables the use of accessories that can display OBD2 data for instrumentation purposes (various OBD2 gauges, mobile phone applications and scan tools) as well as diagnostic trouble code readout. The protocol implemented is ISO15765-4 11 bit OBD over CAN. To enable this functionality, the following configuration parameters must be set:

**CAN bus data mode** 500kbit

**CAN receiving enable** Enabled

**OBD2 service enable** Enabled

For diagnostic trouble codes, see Appendix A

### 4.2.1 Wiring

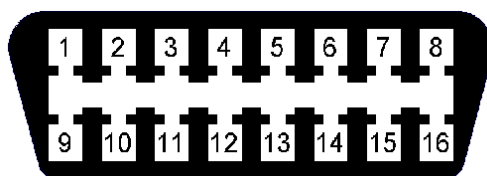

Figure 4.1: OBD2 female connector as seen from the end the scan tool plugs in to.

The OBD2 connector has four essential connections. Pin 6 (CAN-H) . Pin 14 (CAN-L) . Pins 4 and 5 connect to ground (any chassis ground will do) and pin 16 connects to +12V. The standard specifies that the +12V should be taken through a fuse directly from the battery but most OBD2 devices will also perform correctly if the 12V source is switched. For correct operation it may be necessary to have a 120 ohm termination resistor connected across the CAN wires if there is none connected to the CAN bus already.

## A Error codes

The error codes are stored on three bit masks, error0, error1 and error2, as described in the previous chapter. They can be read using the Calibrator application (**Communication -> View controller errors** in on-line mode, **Tools -> Decode error variables** in log view mode). It is also possible to read the errors using an OBD2 scan tool if OBD2 connector is wired and OBD2 communications are enabled in the configuration. OBD2 DTC codes take the form of **P3XZZ** where X is the error variable, 0 for error0 and so on and ZZ is the bit offset in that variable, starting with 00. Note that these codes do not correspond with any auto manufacturer's codes.

Errors that prohibit engine starting:

## B W210 E320 CDI wiring diagram for reference (OM613 engine)

**Document number:** pe07.16-p-2000-99ed  
**Document title:** Wiring diagram of common rail diesel injection (CDI)

<b>Code:</b>	<b>Designation:</b>	<b>Coordinates:</b>
B11/4	Coolant temperature sensor	11 L
B17	Intake air temperature sensor	10 L
B2/5	Hot film MAF sensor	20 L
B28	Pressure sensor	22 L
B4/6	Rail pressure sensor	9 L
B40	Oil sensor (oil level, temperature and quality)	14 L
B6/1	Camshaft Hall sensor	15 L
L5	Crankshaft position sensor	16 L
M55	Inlet port shutoff motor	12 L
N3/9	CDI control module	4 A
N3/9	CDI control module	12 A
N3/9	CDI control module	20 A
Y74	Pressure regulator valve	17 L
Y75	Electrical switch-off valve	18 L
Y76	Injectors (LH-SFI, HFM-SFI, PEC [LH, HFM, PMS])	3 L
Y76y1	Injector cylinder 1	1 L
Y76y2	Injector cylinder 2	4 L
Y76y3	Injector cylinder 3	2 L
Y76y4	Injector cylinder 4	5 L
Y76y5	Fuel injector cylinder 5	6 L
Y76y6	Fuel injector cylinder 6	8 L
Z15	Connector sleeve 7	13 H
Z6/8	Sensor ground connector sleeve	11 H
Z99/6	Common rail solenoid valve 1 connector sleeve	2 H
Z99/7	Common rail solenoid valve 2 connector sleeve	6 H

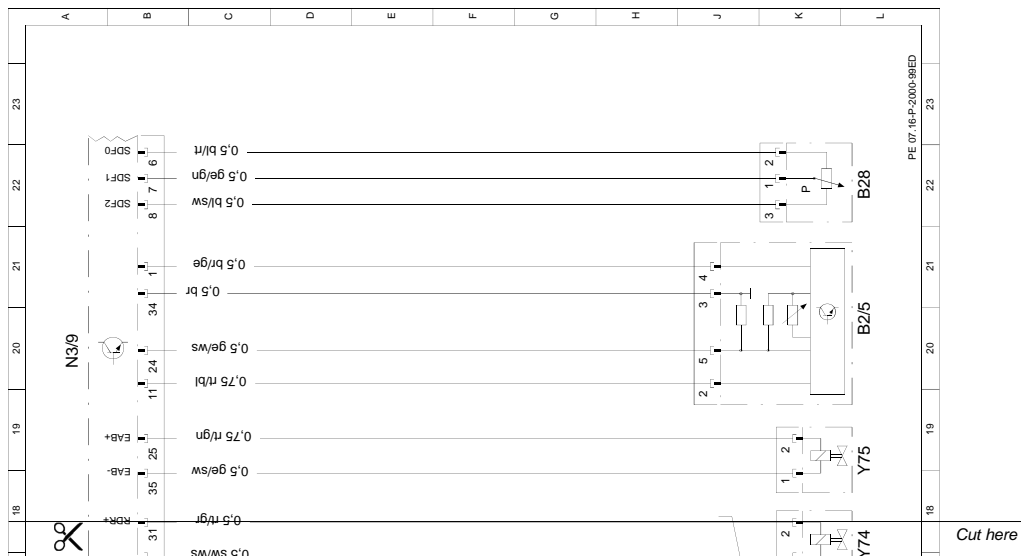

Wiring diagram of common rail diesel injection (CDI) / pe07.16-p-2000-99ed  
 ENGINE 613 in MODEL 210 except CODE (491) U.S. version Connectors 4 and 5 / Printed on: 06.01.2019 / Page 2/2

B. W210 E320 CDI wiring diagram for reference (OM613 engine)

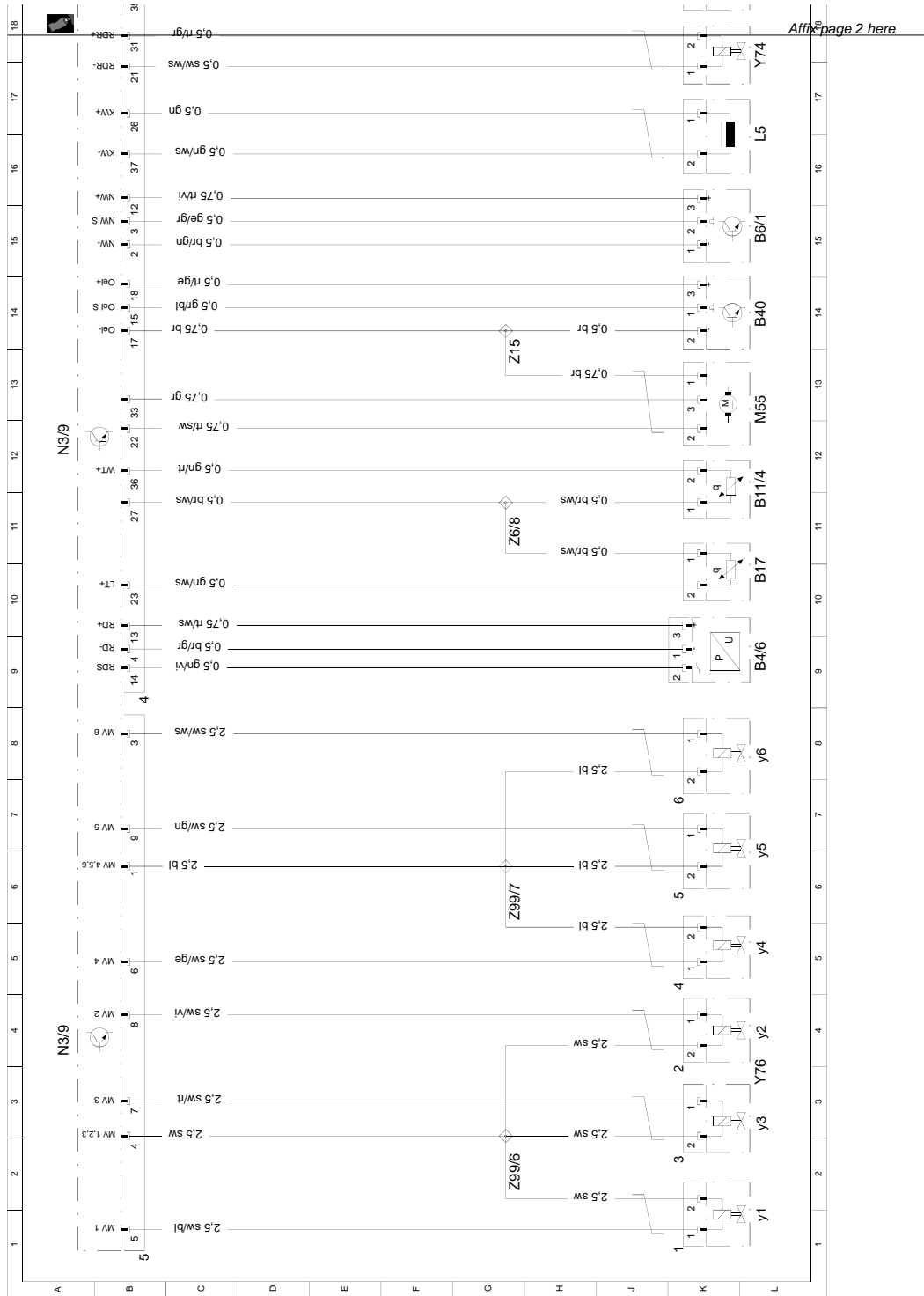

Wiring diagram of common rail diesel injection (CDI) / pe07.16-p-2000-99ed  
ENGINE 613 in MODEL 210 except CODE (491) U.S. version Connectors 4 and 5 / Printed on: 06.01.2019 / Page 1/2

## B. W210 E320 CDI wiring diagram for reference (OM613 engine)

---

**Document number:** pe07.16-p-2000-99ec  
**Document title:** Wiring diagram of common rail diesel injection (CDI) control module

<b>Code:</b>	<b>Designation:</b>	<b>Coordinates:</b>
A1	Instrument cluster	56 L
A1	Instrument cluster	58 L
B37	Accelerator pedal sensor	37 L
F1	Fuse and relay box	49 L
F1f14	Fuse 14	49 K
G1	Battery	16 L
G2	Generator	53 L
K16	Heater booster relay	48 L
K40/4	Fuse and relay module (front passenger)	18 L
K40/4	Fuse and relay module (front passenger)	24 L
K40/4	Fuse and relay module (front passenger)	60 H
K40/4f1	Fuse, circuit 30z	19 L
K40/4f2	Fuse 2, diesel engine control module power supply	24 L
K40/4f3	Fuse 1, diesel engine control module power supply	23 L
K40/4f5	Fuse, ETC/ADS [EGS/ADS]	25 L
K40/4k1	Polarity protection relay	17 L
K40/4k2	Starter relay	20 L
K40/4k3	Diesel voltage supply relay	22 L
M1	Starter	32 L
M2/2	Control module box blower motor	30 L
N14/2	Preglow output	41 L
N15/5	Electronic selector lever module control module	14 L
N3/9	CDI control module	12 A
N3/9	CDI control module	20 A
N3/9	CDI control module	27 A
N3/9	CDI control module	36 A
N3/9	CDI control module	44 A
N3/9	CDI control module	52 A
N3/9	CDI control module	59 A
N33/2	Heater booster control module	45 L
N33/2x1	Heater booster control module connector	46 K
N73	DI control module	3 L
N73	DI control module	9 L
R39/1	Vent line heater element	33 L
R9	Glow plugs	40 E
S4/3	Heater booster switch	60 L
S40/4	CC with variable speed limiter switch	3 A
S40/4s1	Resume from memory	3 C
S40/4s2	Decelerate and set	3 C

## B. W210 E320 CDI wiring diagram for reference (OM613 engine)

---

**Document number:** pe07.16-p-2000-99ec  
**Document title:** Wiring diagram of common rail diesel injection (CDI) control module

<b>Code:</b>	<b>Designation:</b>	<b>Coordinates:</b>
S40/4s3	Accelerate and set	3 B
S40/4s4	Off	3 B
S40/4s5	Control contact	3 B
S40/4s6	Variable speed	4 C
U12	Valid for left-hand steering	27 D
U12	Valid for left-hand steering	29 D
U12	Valid for left-hand steering	31 D
U13	Valid for right-hand steering	26 D
U13	Valid for right-hand steering	28 D
U13	Valid for right-hand steering	29 H
U13	Valid for right-hand steering	30 D
W1	Main ground (behind instrument cluster)	9 H
W11/3	Ground (engine - left side)	33 H
W16/3	Ground (output ground-left wheel housing)	39 H
W16/4	Ground (output ground - right wheel housing)	21 E
W16/5	Electronics ground (left of component compartment)	26 E
W16/5	Electronics ground (left of component compartment)	28 E
W16/5	Electronics ground (left of component compartment)	30 E
W16/6	Electronics ground (right of component compartment)	26 E
W16/6	Electronics ground (right of component compartment)	28 E
W16/6	Electronics ground (right of component compartment)	30 E
X11/4	Data link connector	20 E
X11/4	Data link connector	26 E
X11/4	Data link connector	39 E
X12/3	Terminal block (circuit 30)	42 H
X12/3	Terminal block (circuit 30)	51 L
X12/3f1	Generator prefuse	43 G
X12/3f1	Generator prefuse	51 K
X22	Engine compartment and engine connector	53 E
X4	Terminal block (circuit 30, left footwell)	8 G
X4	Terminal block (circuit 30, left footwell)	31 H
X4	Terminal block (circuit 30, left footwell)	43 E
X4/2	Circuit 30 connector, heater booster, generator	50 E
X4/3	Circuit 30 connector, heater booster, battery	50 H
X63/6	CAN databus/15u connector	5 G
Y31/4	EGR [ARF]/pressure control flap vacuum transducer	34 L
Y31/5	Boost pressure control vacuum transducer	35 L
Z26	Circuit 61e connector sleeve	60 E
Z37/13	CAN engine bus (low) connector sleeve	6 H



## B. W210 E320 CDI wiring diagram for reference (OM613 engine)

---

**Document number:** pe07.16-p-2000-99ec  
**Document title:** Wiring diagram of common rail diesel injection (CDI) control module

<b>Code:</b>	<b>Designation:</b>	<b>Coordinates:</b>
Z37/14	CAN engine bus (high) connector sleeve	5 H
Z37/2	CAN engine bus (low) connector sleeve	6 D
Z37/3	CAN engine bus (high) connector sleeve	5 D
Z7/24	Circuit 87 connector sleeve	24 E
Z7/30	Circuit 30 (unfused) connector sleeve	8 H
Z9	Connector sleeve 1	17 E

B. W210 E320 CDI wiring diagram for reference (OM613 engine)

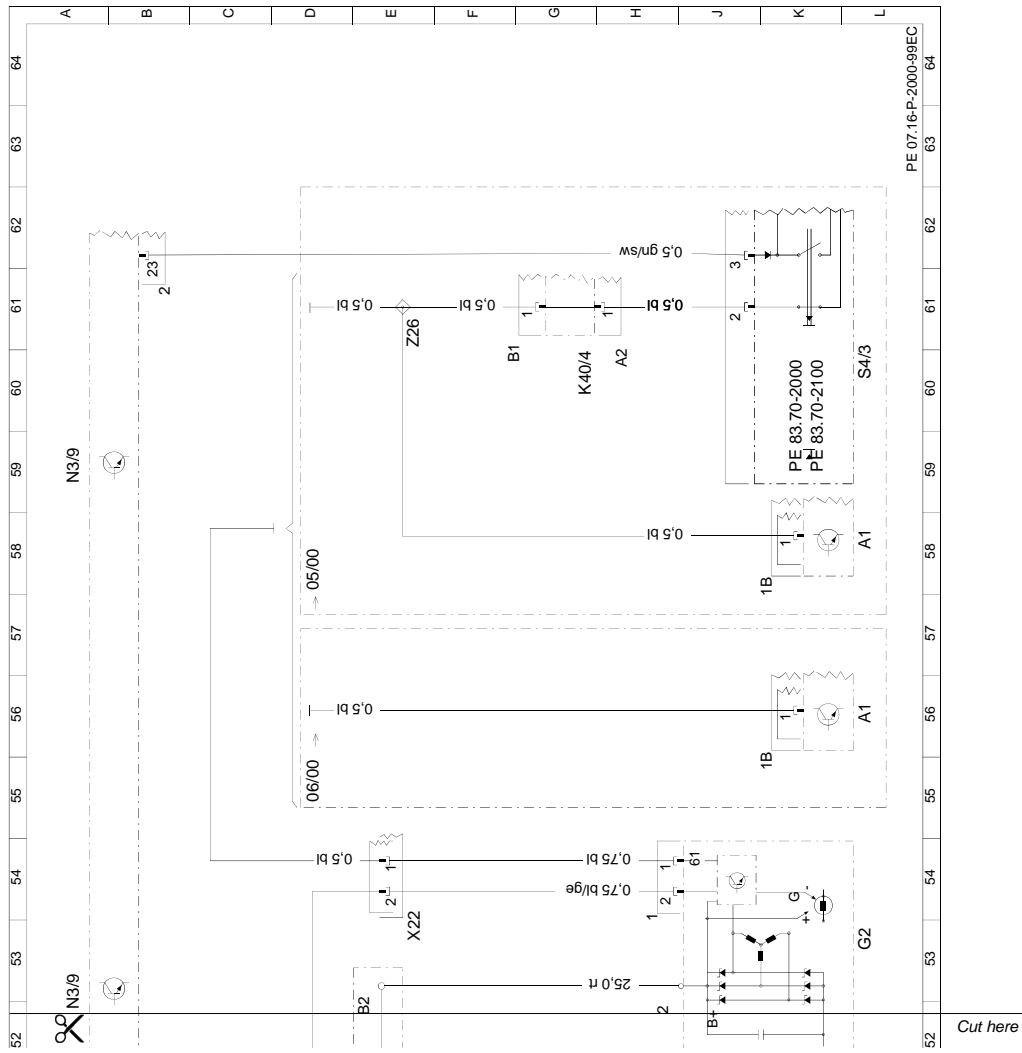

Wiring diagram of common rail diesel injection (CDI) control module / pe07.16-p-2000-99ec  
 ENGINE 613 in MODEL 210 except CODE (491) U.S. version with CODE (440a) Cruise control plug 1 - 3, with electrical heater booster /

B. W210 E320 CDI wiring diagram for reference (OM613 engine)

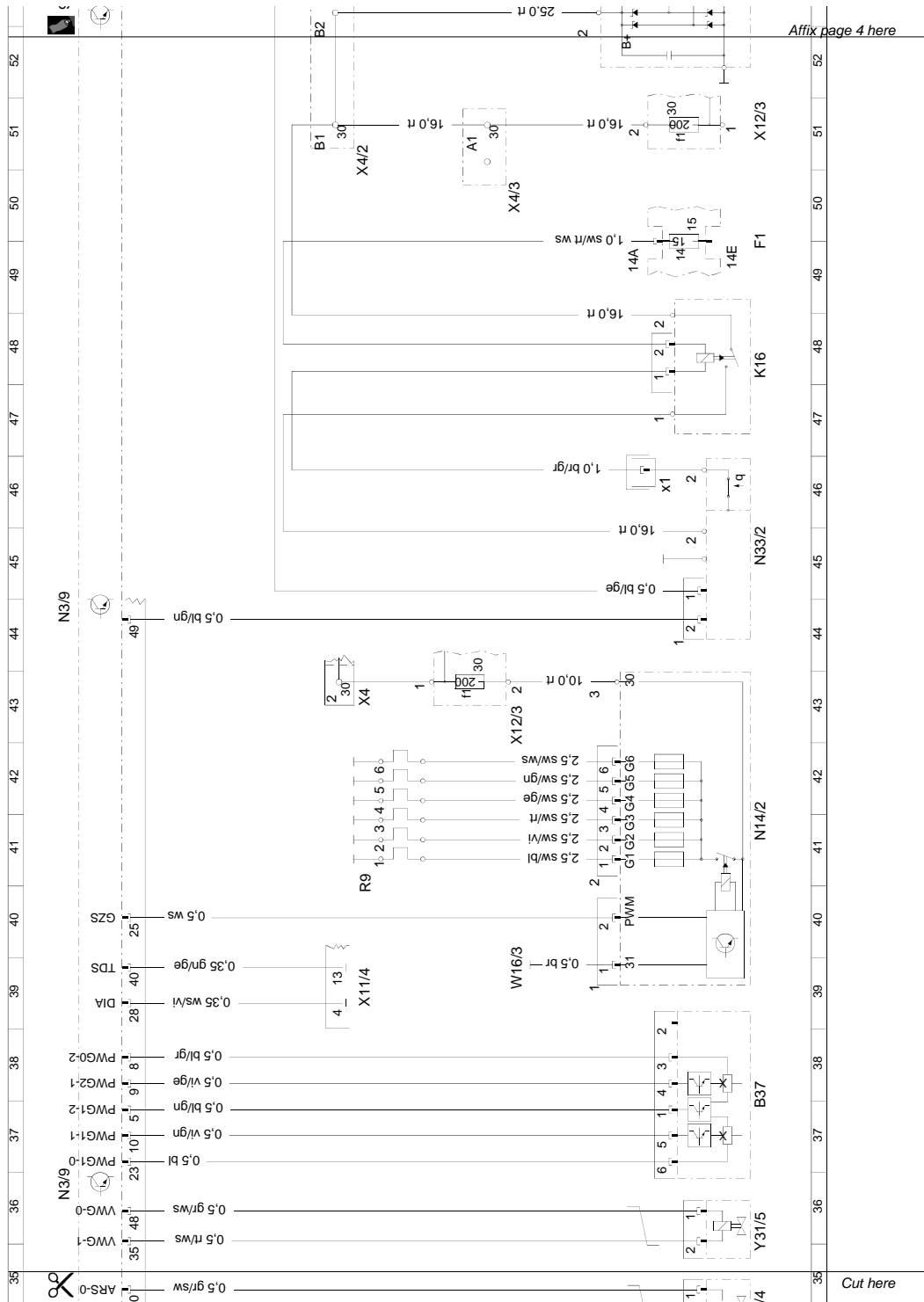

Wiring diagram of common rail diesel injection (CDI) control module / pe07.16-p-2000-99ec ENGINE 613 in MODEL 210 except CODE (491) U.S. version with CODE (440a) Cruise control plug 1 - 3, with electrical heater booster /

B. W210 E320 CDI wiring diagram for reference (OM613 engine)

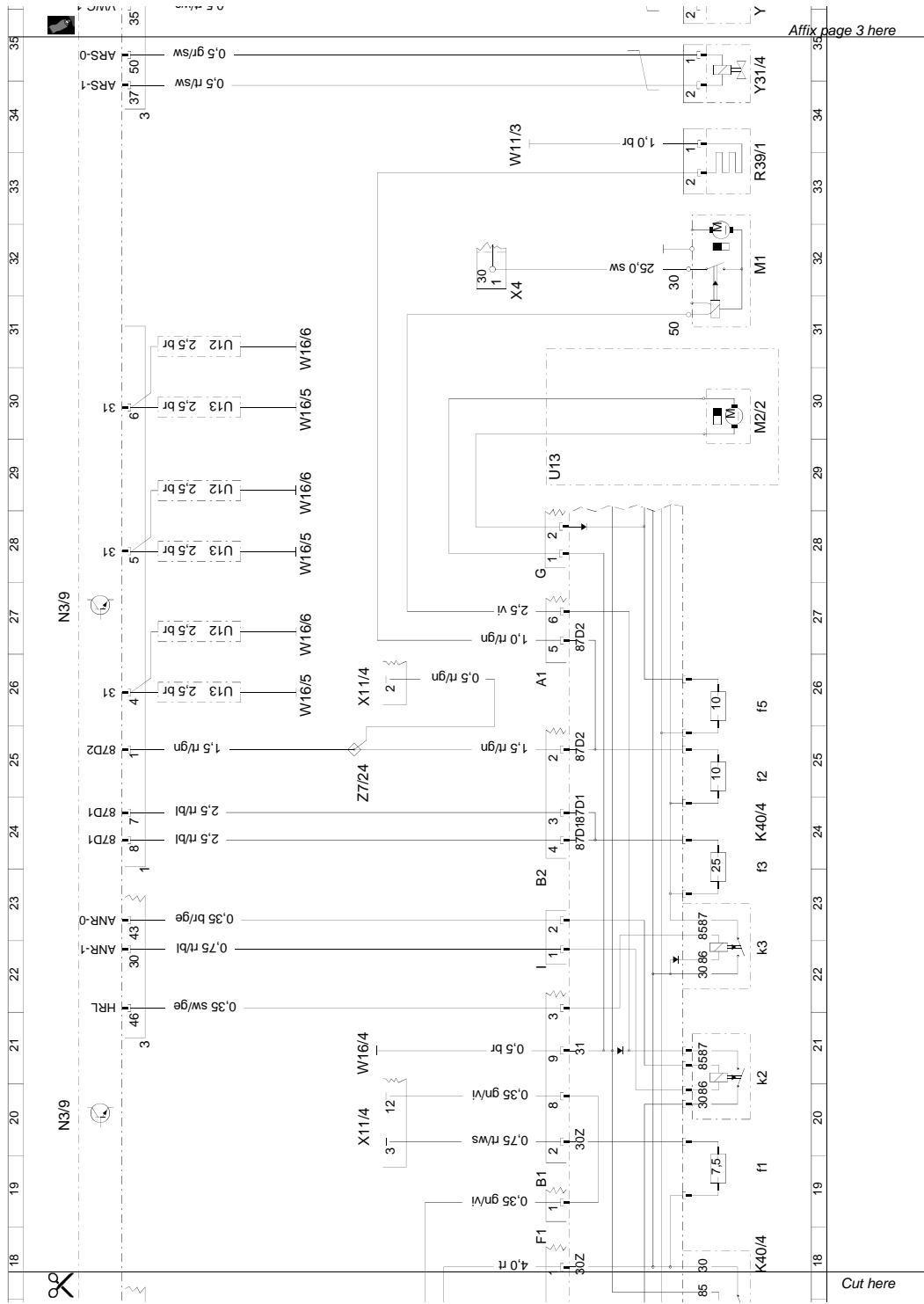

Wiring diagram of common rail diesel injection (CDI) control module / pe07.16-p-2000-99ec ENGINE 613 in MODEL 210 except CODE (491) U.S. version with CODE (440a) Cruise control plug 1 - 3, with electrical heater booster /

B. W210 E320 CDI wiring diagram for reference (OM613 engine)

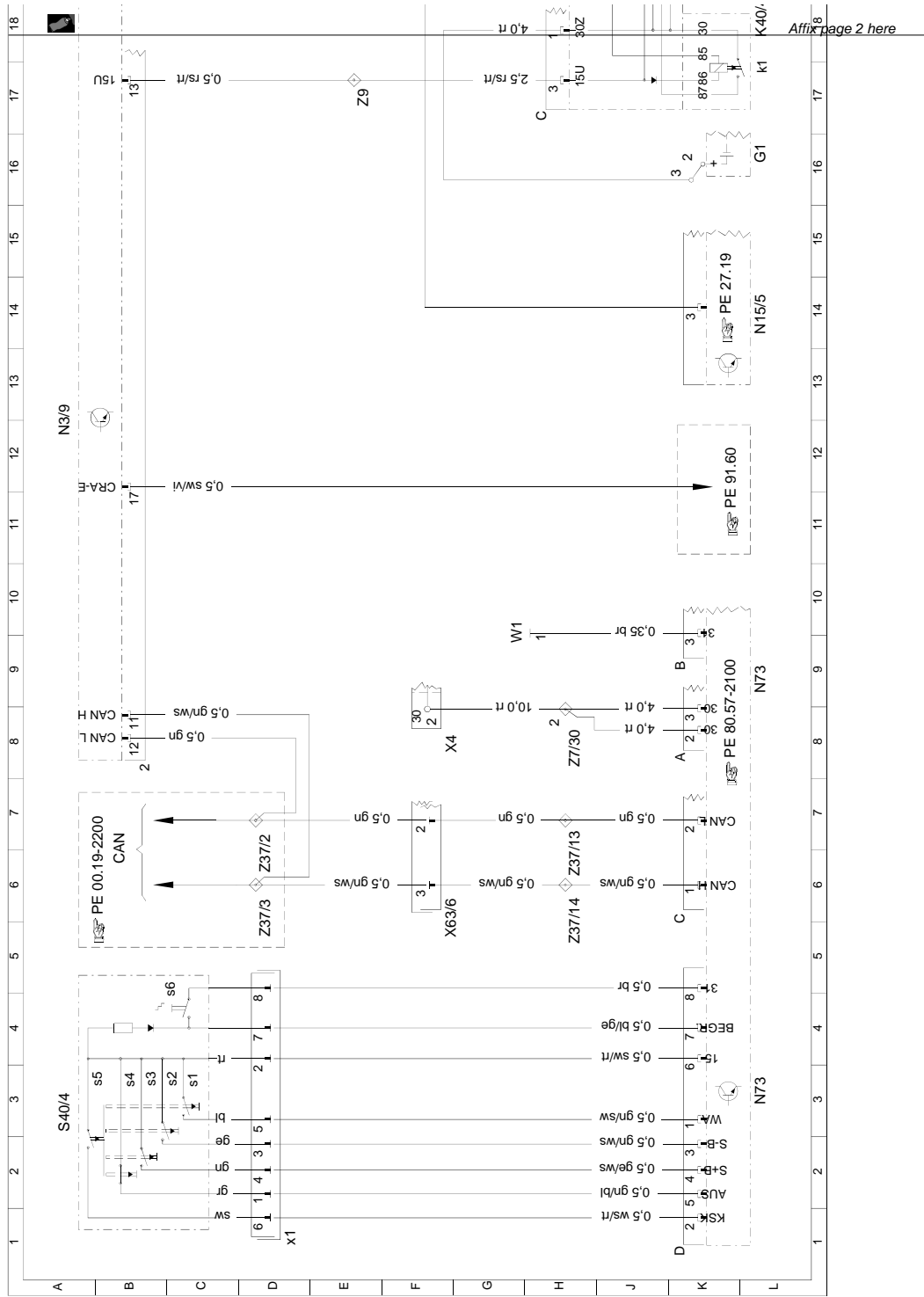

Wiring diagram of common rail diesel injection (CDI) control module / pe07.16-p-2000-99ec ENGINE 613 in MODEL 210 except CODE (491) U.S. version with CODE (440a) Cruise control plug 1 - 3, with electrical heater booster /

C. W210 E220 or E270 CDI wiring diagram for reference (OM611 or OM612 engine)

---

## C W210 E220 or E270 CDI wiring diagram for reference (OM611 or OM612 engine)

**Document number:** pe07.16-p-2000-99ea  
**Document title:** Wiring diagram of common rail diesel injection (CDI) control module

<b>Code:</b>	<b>Designation:</b>	<b>Coordinates:</b>
A1	Instrument cluster	69 L
A1	Instrument cluster	72 L
B17	Intake air temperature sensor	40 L
B28	Pressure sensor	41 L
B37	Accelerator pedal sensor	45 L
F1	Fuse and relay box	56 L
F1	Fuse and relay box	63 L
F1f14	Fuse 14	63 K
F1f20	Maxi-fuse 20	56 K
G1	Battery	20 L
G2	Generator	67 L
K16	Heater booster relay	61 L
K40/2	Driver-side fuse and relay module	18 E
K40/2	Driver-side fuse and relay module	52 E
K40/4	Fuse and relay module (front passenger)	22 L
K40/4	Fuse and relay module (front passenger)	28 L
K40/4	Fuse and relay module (front passenger)	73 H
K40/4f1	Fuse, circuit 30z	23 L
K40/4f2	Fuse 2, diesel engine control module power supply	29 L
K40/4f3	Fuse 1, diesel engine control module power supply	27 L
K40/4f5	Fuse, ETC/ADS [EGS/ADS]	29 L
K40/4k1	Polarity protection relay	21 L
K40/4k2	Starter relay	24 L
K40/4k3	Diesel voltage supply relay	26 L
M1	Starter	37 L
M2/2	Control module box blower motor	34 L
M4/3	Electric suction-type fan (engine / AAC )	55 L
M4/3x1	Electric suction-type fan (engine / AAC) connector	54 K
N14/2	Preglow output	48 L
N15/5	Electronic selector lever module control module	15 L
N19	AAC pushbutton control module	18 L
N22	AAC pushbutton control module	19 L
N3/9	CDI control module	13 A
N3/9	CDI control module	20 A
N3/9	CDI control module	29 A
N3/9	CDI control module	36 A
N3/9	CDI control module	44 A
N3/9	CDI control module	52 A
N3/9	CDI control module	60 A

C. W210 E220 or E270 CDI wiring diagram for reference (OM611 or OM612 engine)

---

**Document number:** pe07.16-p-2000-99ea  
**Document title:** Wiring diagram of common rail diesel injection (CDI) control module

<b>Code:</b>	<b>Designation:</b>	<b>Coordinates:</b>
N3/9	CDI control module	69 A
N3/9	CDI control module	74 A
N33/2	Heater booster control module	58 L
N33/2x1	Heater booster control module connector	59 K
N73	DI control module	3 L
N73	DI control module	8 L
N76	Engine and air conditioning electric suction fan control module	53 L
R39/1	Vent line heater element	38 L
R9	Glow plugs	48 E
S16/6	Kickdown switch	11 L
S4/3	Heater booster switch	74 L
S40/3	Clutch pedal switch	13 L
S40/4	CC with variable speed limiter switch	3 A
S40/4s1	Resume from memory	3 C
S40/4s2	Decelerate and set	3 C
S40/4s3	Accelerate and set	3 B
S40/4s4	Off	3 B
S40/4s5	Control contact	3 B
S40/4s6	Variable speed	4 C
S40/4x1	Variable cruise control switch connector	1 D
U12	Valid for left-hand steering	12 J
U12	Valid for left-hand steering	12 J
U12	Valid for left-hand steering	31 D
U12	Valid for left-hand steering	37 D
U12	Valid for left-hand steering	39 D
U13	Valid for right-hand steering	11 J
U13	Valid for right-hand steering	13 J
U13	Valid for right-hand steering	30 D
U13	Valid for right-hand steering	34 H
U13	Valid for right-hand steering	36 D
U13	Valid for right-hand steering	38 D
U199	Valid for engine 612	50 H
U24	Valid for MT [MG]	10 F
U25	Valid for automatic transmission	14 F
U29	Valid for outside temperature indicator	19 H
U87	Valid for AAC [KLA]	18 H
W1	Main ground (behind instrument cluster)	9 H
W11/3	Ground (engine - left side)	39 H
W16/3	Ground (output ground-left wheel housing)	47 H



C. W210 E220 or E270 CDI wiring diagram for reference (OM611 or OM612 engine)

---

**Document number:** pe07.16-p-2000-99ea  
**Document title:** Wiring diagram of common rail diesel injection (CDI) control module

<b>Code:</b>	<b>Designation:</b>	<b>Coordinates:</b>
W16/3	Ground (output ground-left wheel housing)	52 H
W16/4	Ground (output ground - right wheel housing)	25 E
W16/5	Electronics ground (left of component compartment)	30 E
W16/5	Electronics ground (left of component compartment)	36 E
W16/5	Electronics ground (left of component compartment)	38 E
W16/6	Electronics ground (right of component compartment)	31 E
W16/6	Electronics ground (right of component compartment)	37 E
W16/6	Electronics ground (right of component compartment)	39 E
W18	Ground (left front seat crossmember)	12 H
W19	Ground (right front seat crossmember)	13 H
X11/4	Data link connector	24 E
X11/4	Data link connector	30 E
X11/4	Data link connector	47 E
X12/3	Terminal block (circuit 30)	50 H
X12/3	Terminal block (circuit 30)	64 L
X12/3f1	Generator prefuse	51 G
X12/3f1	Generator prefuse	64 K
X22	Engine compartment and engine connector	67 E
X4	Terminal block (circuit 30, left footwell)	8 G
X4	Terminal block (circuit 30, left footwell)	36 H
X4	Terminal block (circuit 30, left footwell)	51 E
X4/2	Circuit 30 connector, heater booster, generator	64 E
X4/3	Circuit 30 connector, heater booster, battery	63 H
X63/6	CAN databus/15u connector	5 G
Y31/4	EGR [ARF]/pressure control flap vacuum transducer	42 L
Y31/5	Boost pressure control vacuum transducer	43 L
Z26	Circuit 61e connector sleeve	74 E
Z37/13	CAN engine bus (low) connector sleeve	6 H
Z37/14	CAN engine bus (high) connector sleeve	5 H
Z37/2	CAN engine bus (low) connector sleeve	6 D
Z37/3	CAN engine bus (high) connector sleeve	5 D
Z7/24	Circuit 87 connector sleeve	29 E
Z7/30	Circuit 30 (unfused) connector sleeve	7 H
Z9	Connector sleeve 1	9 E
Z9	Connector sleeve 1	21 E

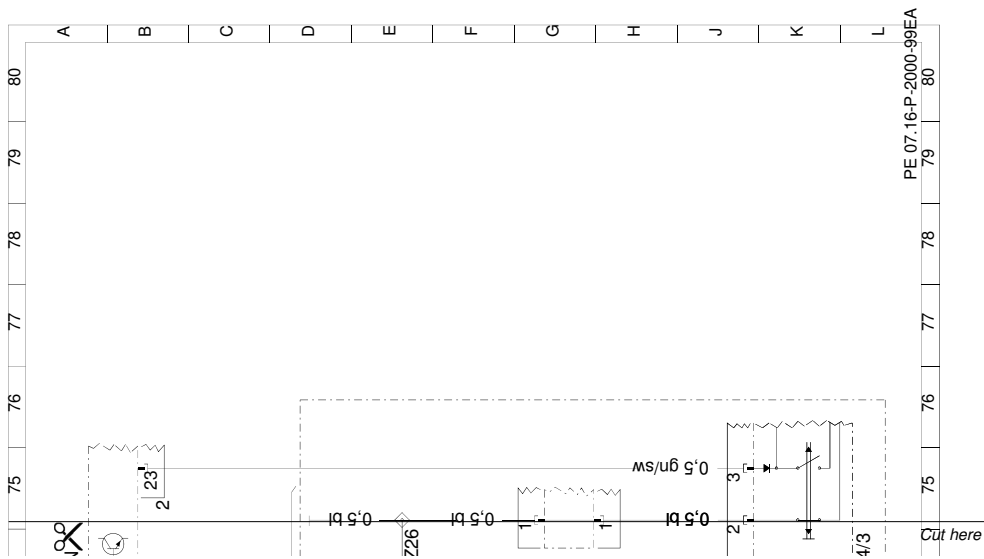

Wiring diagram of common rail diesel injection (CDI) control module / pe07.16-p-2000-99ea ENGINE 611 as of 1.6.99, 612 in MODEL 210 with CODE (440a) Cruise control connectors 1 - 3, with electric heater booster / Printed on: 15.12.20

C. W210 E220 or E270 CDI wiring diagram for reference (OM611 or OM612 engine)

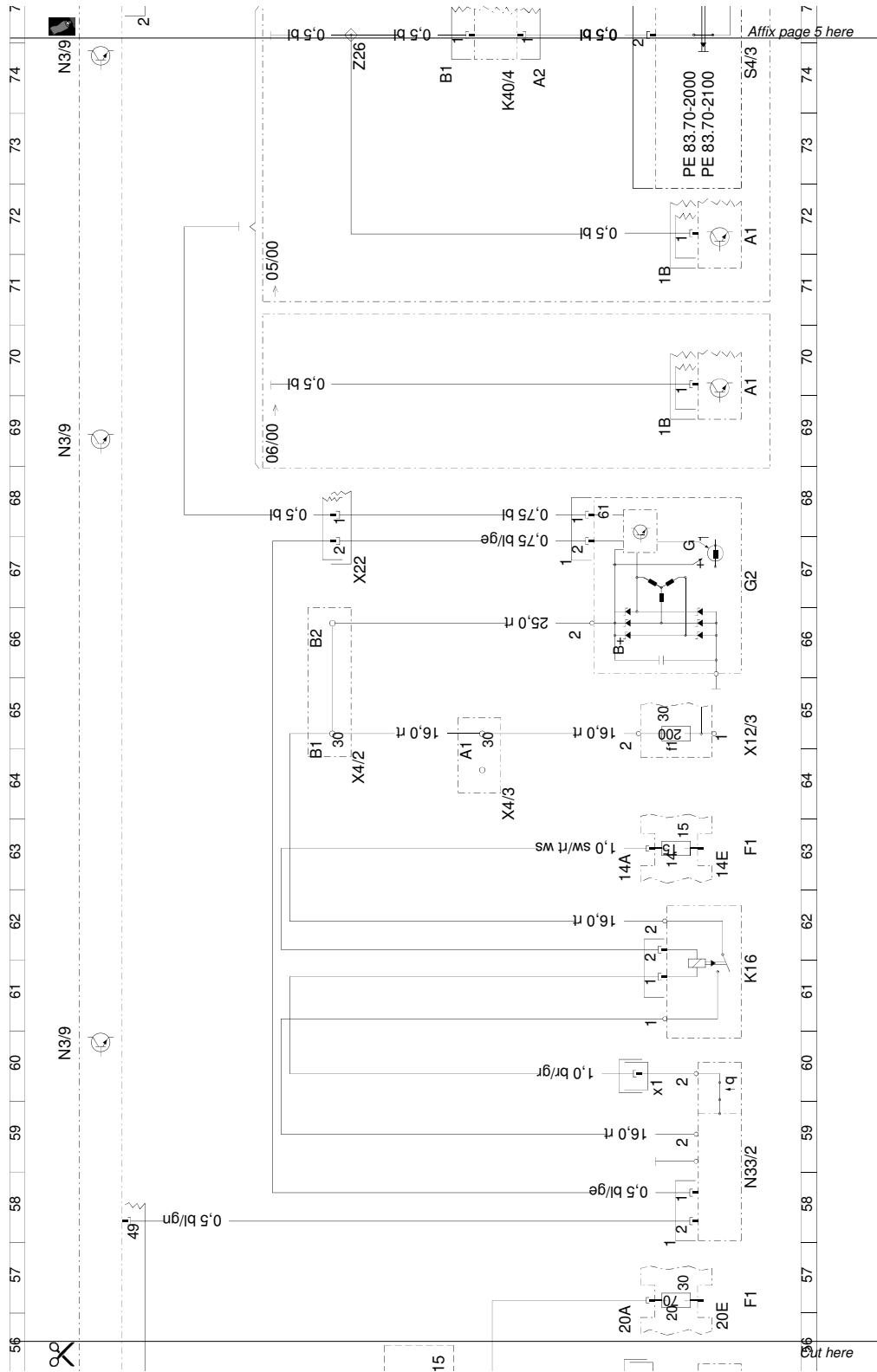

Wiring diagram of common rail diesel injection (CDI) control module / pe07.16-p-2000-99ea ENGINE 611 as of 1.6.99, 612 in MODEL 210 with CODE (440a) Cruise control connectors 1 - 3, with electric heater booster / Printed on: 15.12.21

C. W210 E220 or E270 CDI wiring diagram for reference (OM611 or OM612 engine)

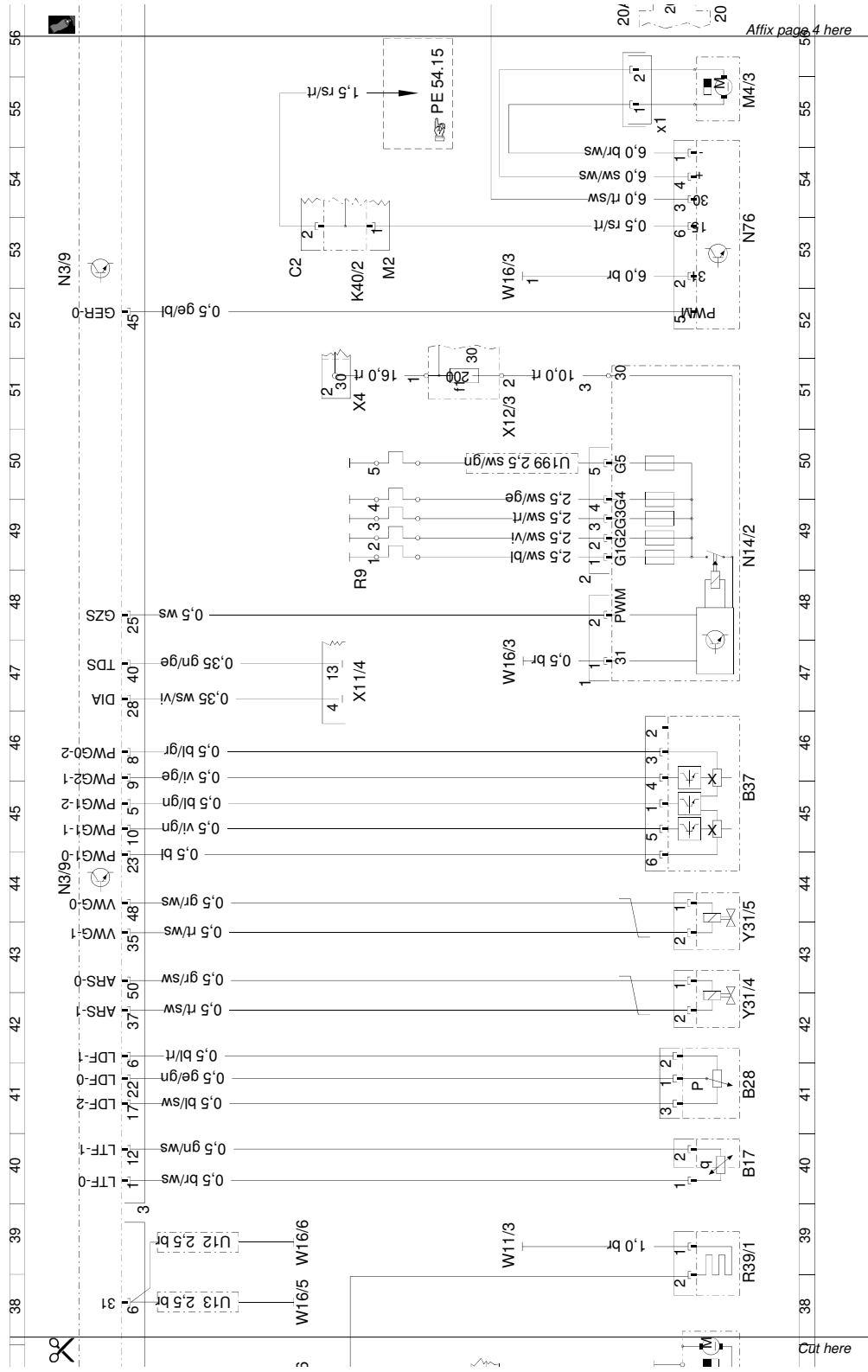

Wiring diagram of common rail diesel injection (CDI) control module / pe07.16-p-2000-99ea ENGINE 611 as of 1.6.99, 612 in MODEL 210 with CODE (440a) Cruise control connectors 1 - 3, with electric heater booster / Printed on: 15.12.21

C. W210 E220 or E270 CDI wiring diagram for reference (OM611 or OM612 engine)

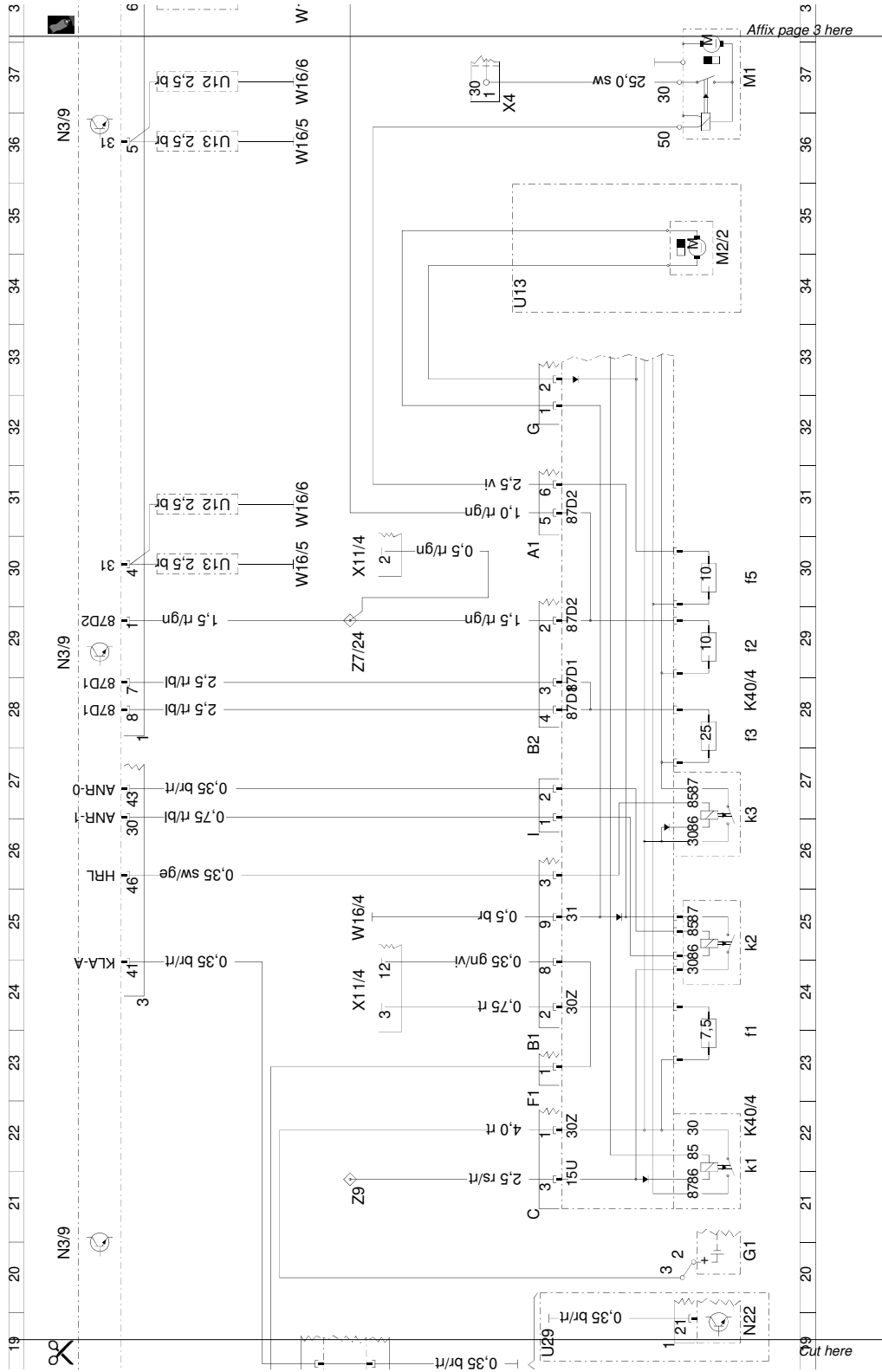

Wiring diagram of common rail diesel injection (CDI) control module / pe07.16-p-2000-99ea ENGINE 611 as of 1.6.99, 612 in MODEL 210 with CODE (440a) Cruise control connectors 1 - 3, with electric heater booster / Printed on: 15.12.21

C. W210 E220 or E270 CDI wiring diagram for reference (OM611 or OM612 engine)

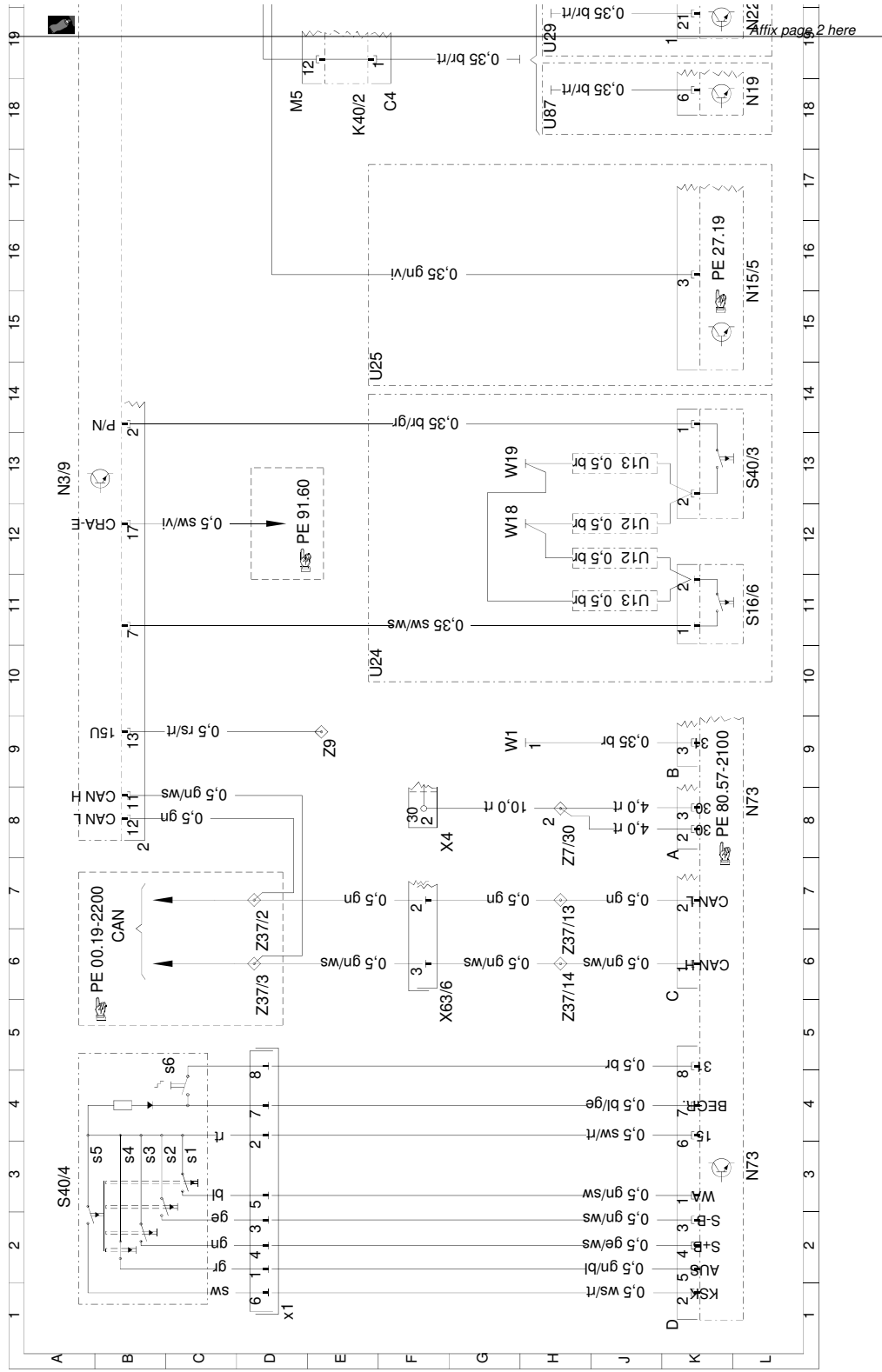

Wiring diagram of common rail diesel injection (CDI) control module / pe07.16-p-2000-99ea ENGINE 611 as of 1.6.99, 612 in MODEL 210 with CODE (440a) Cruise control connectors 1 - 3, with electric heater booster / Printed on: 15.12.21

C. W210 E220 or E270 CDI wiring diagram for reference (OM611 or OM612 engine)

---

**Document number:** pe07.16-p-2000-99eb  
**Document title:** Wiring diagram of common rail diesel injection (CDI) control module

<b>Code:</b>	<b>Designation:</b>	<b>Coordinates:</b>
B11/4	Coolant temperature sensor	15 L
B2/5	Hot film MAF sensor	24 L
B4/6	Rail pressure sensor	14 L
B40	Oil sensor (oil level, temperature and quality)	18 L
B6/1	Camshaft Hall sensor	19 L
L5	Crankshaft position sensor	20 L
M55	Inlet port shutoff motor	16 L
N3/9	CDI control module	4 A
N3/9	CDI control module	12 A
N3/9	CDI control module	19 A
U198	Valid for engine 611	1 A
U199	Valid for engine 612	7 A
Y74	Pressure regulator valve	21 L
Y75	Electrical switch-off valve	22 L
Y76	Injectors (LH-SFI, HFM-SFI, PEC [LH, HFM, PMS])	4 L
Y76	Injectors (LH-SFI, HFM-SFI, PEC [LH, HFM, PMS])	9 L
Y76y1	Injector cylinder 1	2 L
Y76y1	Injector cylinder 1	7 L
Y76y2	Injector cylinder 2	4 L
Y76y2	Injector cylinder 2	11 L
Y76y3	Injector cylinder 3	5 L
Y76y3	Injector cylinder 3	9 L
Y76y4	Injector cylinder 4	3 L
Y76y4	Injector cylinder 4	10 L
Y76y5	Fuel injector cylinder 5	12 L
Z15	Connector sleeve 7	17 H
Z99/6	Common rail solenoid valve 1 connector sleeve	2 H
Z99/6	Common rail solenoid valve 1 connector sleeve	8 H
Z99/7	Common rail solenoid valve 2 connector sleeve	5 H
Z99/7	Common rail solenoid valve 2 connector sleeve	12 H

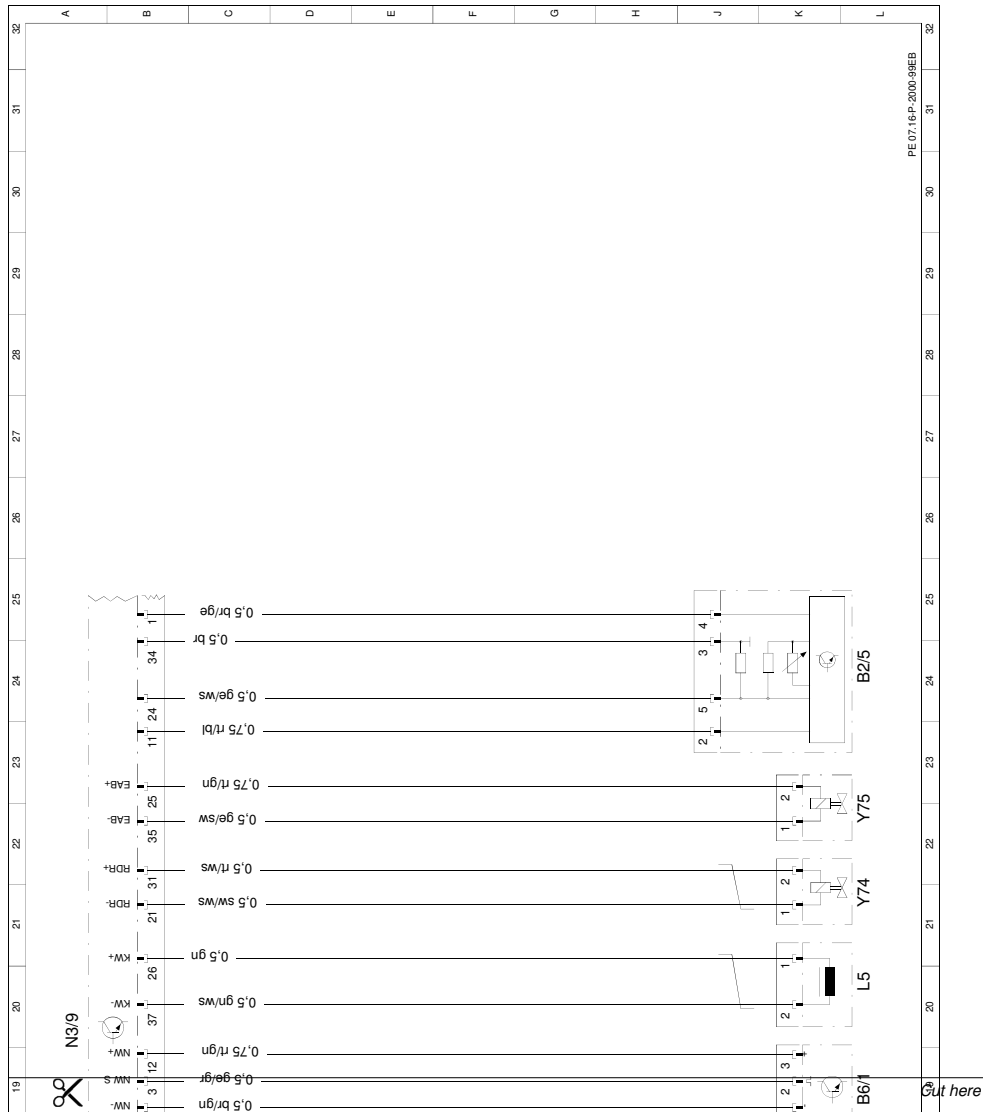

Wiring diagram of common rail diesel injection (CDI) control module / pe07.16-p-2000-99eb ENGINE 611 as of 1.6.99, 612 in MODEL 210 connectors 4 and 5 / Printed on: 15.12.2019 / Page 2/2



C. W210 E220 or E270 CDI wiring diagram for reference (OM611 or OM612 engine)

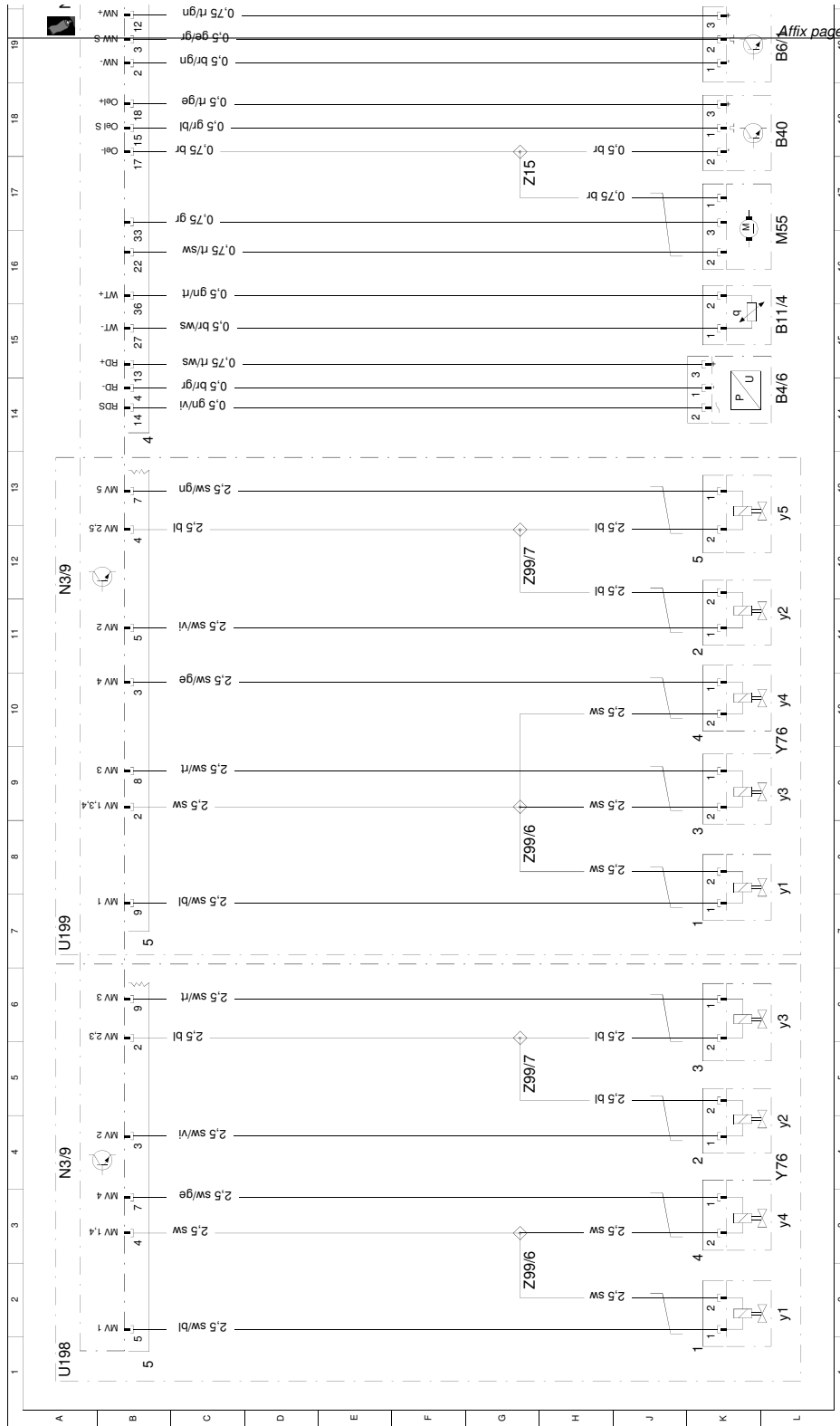

Affix page 2 here

Wiring diagram of common rail diesel injection (CDI) control module / pe07.16-p-2000-99eb  
ENGINE 611 as of 1.6.99, 612 in MODEL 210 connectors 4 and 5 / Printed on: 15.12.2019 / Page 1/2

## D W163 ML270 CDI wiring diagram for reference (OM612 engine)

**Document number:** pe07.16-p-2000-99gh  
**Document title:** Wiring diagram of common rail diesel injection (CDI) control module

<b>Code:</b>	<b>Designation:</b>	<b>Coordinates:</b>
B11/4	Coolant temperature sensor	40 L
B17	IAT sensor	33 L
B2/5	Hot film MAF sensor	35 L
B28	Pressure sensor	30 L
B4/6	Rail pressure sensor	48 L
B40	Oil sensor (oil level, temperature and quality)	45 L
B6/1	Camshaft Hall sensor	37 L
F1	Fuse and relay module	2 C
F1	Fuse and relay module	27 C
F1f14	Fuse 14	11 C
F1k11	Circuit 15 delayed relay	9 D
F1k12	Circuit 15 relay	5 D
F24/8	Circuit 15 auxiliary fuse	11 L
G1	Battery	4 H
L5	Crankshaft position sensor	42 L
M55	Inlet port shutoff motor	46 L
N10	All-activity module	4 A
N10	All-activity module	10 A
N14/2	Preglow output	24 L
N3/9	CDI control module	17 A
N3/9	CDI control module	27 A
N3/9	CDI control module	37 A
N3/9	CDI control module	47 A
N3/9	CDI control module	56 A
R39/1	Vent line heater element	17 L
R9	Glow plugs	24 C
R9	Glow plugs	24 C
R9	Glow plugs	25 C
R9	Glow plugs	25 C
R9	Glow plugs	26 C
S2	Starter switch	3 L
W11/3	Ground (engine - left side)	16 H
W16/4	Ground (output ground - component compartment - right)	6 L
W16/5	Electronics ground (left of component compartment)	18 F
W2	Ground (at right headlamp unit)	23 C
X12/3	Terminal block (circuit 30, 15, 31, 3-pin)	4 E
X12/3	Terminal block (circuit 30, 15, 31, 3-pin)	27 E
X18/31	Left engine compartment/right engine compartment connector	29 G
X22	Engine compartment and engine connector	17 G

**Document number:** pe07.16-p-2000-99gh  
**Document title:** Wiring diagram of common rail diesel injection (CDI) control module

<b>Code:</b>	<b>Designation:</b>	<b>Coordinates:</b>
X4/37	Circuit 30 terminal block	4 F
Y31/5	Boost pressure control vacuum transducer	28 L
Y74	Pressure regulator valve	43 L
Y75	Electrical switch-off valve	39 L
Y76y1	Fuel injector (1st cylinder)	50 L
Y76y2	Fuel injector (2nd cylinder)	54 L
Y76y3	Fuel injector (3rd cylinder)	53 L
Y76y4	Fuel injector (4th cylinder)	51 L
Y76y5	UNBEKANNT	56 L
Z18	Connector sleeve 10	45 F
Z50/5	Cockpit connector sleeve (circuit 30)	2 G
Z50/6	Cockpit connector sleeve (circuit 15C)	1 H
Z50/9	Cockpit connector sleeve II (circuit 15)	1 G
Z57/11	Right engine compartment, circuit 15 connector sleeve	15 F
Z57/7	Connector sleeve in right of engine compartment, circuit 31 (3)	18 D
Z57/7	Connector sleeve in right of engine compartment, circuit 31 (3)	23 F
Z99/6	Common rail solenoid valve 1 connector sleeve	50 G
Z99/7	Common rail solenoid valve 2 connector sleeve	54 G

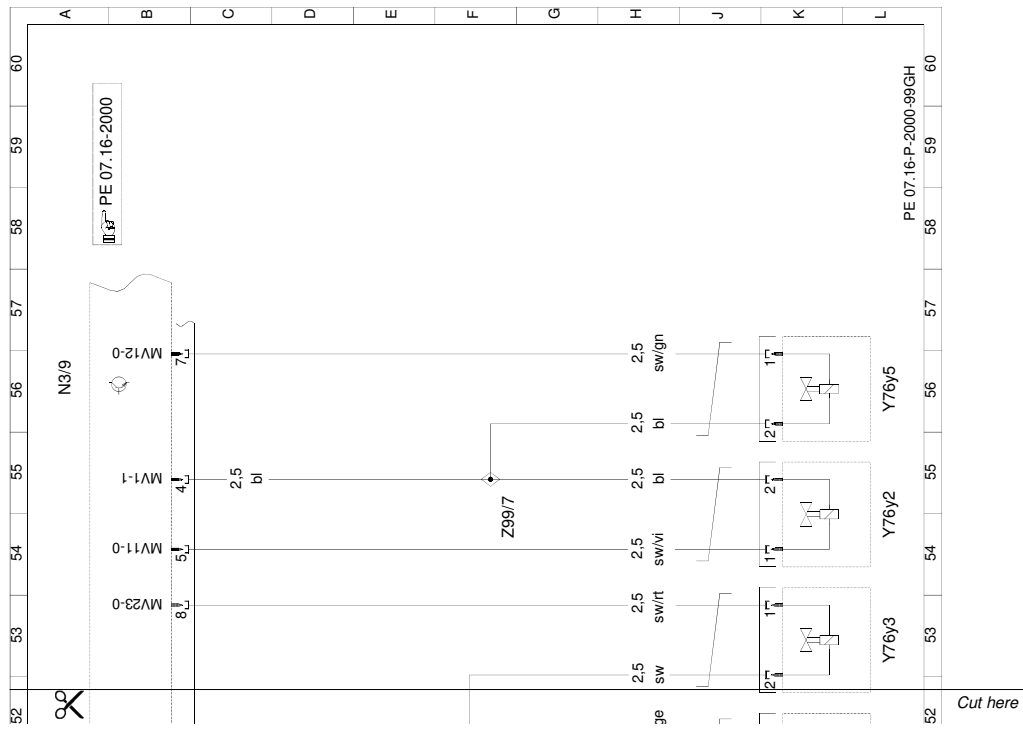

Wiring diagram of common rail diesel injection (CDI) control module / pe07.16-p-2000-99gh  
 ENGINE 612 in MODEL 163 up to 31.8.01 Engine block wiring harnesses / Printed on: 07.12.2019 / Page 4/4

D. W163 ML270 CDI wiring diagram for reference (OM612 engine)

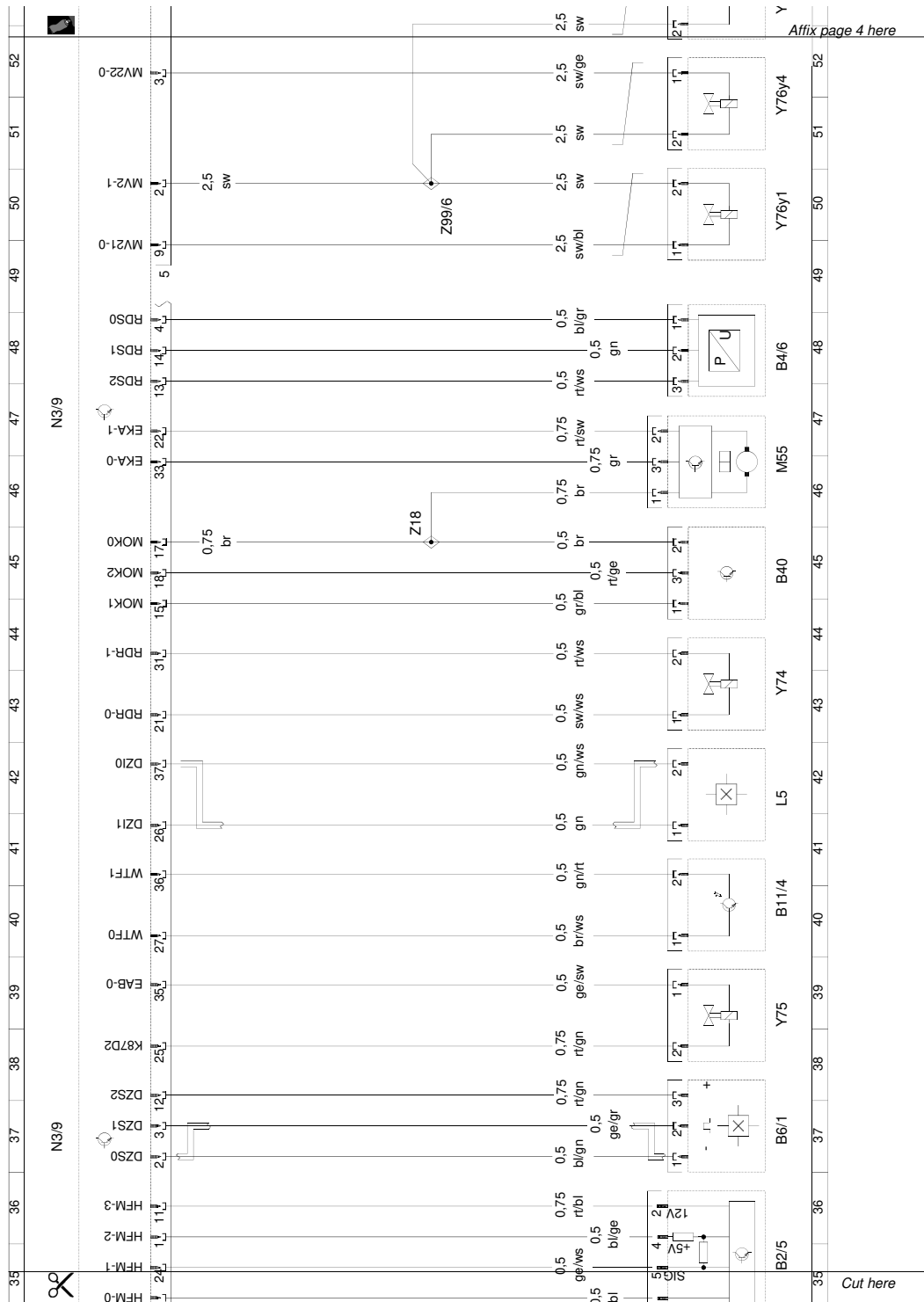

Wiring diagram of common rail diesel injection (CDI) control module / pe07.16-p-2000-99gh  
 ENGINE 612 in MODEL 163 up to 31.8.01 Engine block wiring harnesses / Printed on: 07.12.2019 / Page 3/4

D. W163 ML270 CDI wiring diagram for reference (OM612 engine)

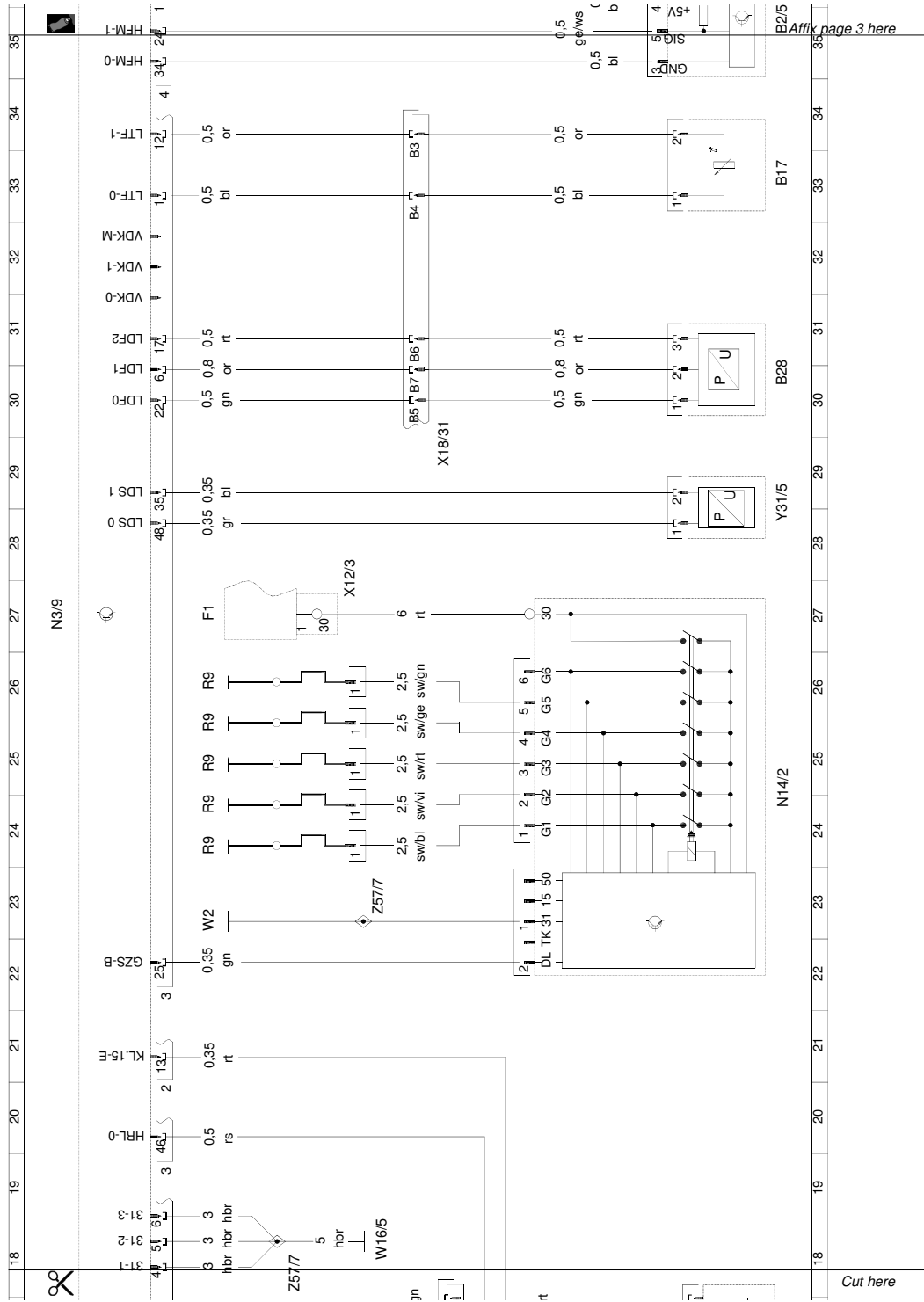

Wiring diagram of common rail diesel injection (CDI) control module / pe07.16-p-2000-99gh  
ENGINE 612 in MODEL 163 up to 31.8.01 Engine block wiring harnesses / Printed on: 07.12.2019 / Page 2/4

D. W163 ML270 CDI wiring diagram for reference (OM612 engine)

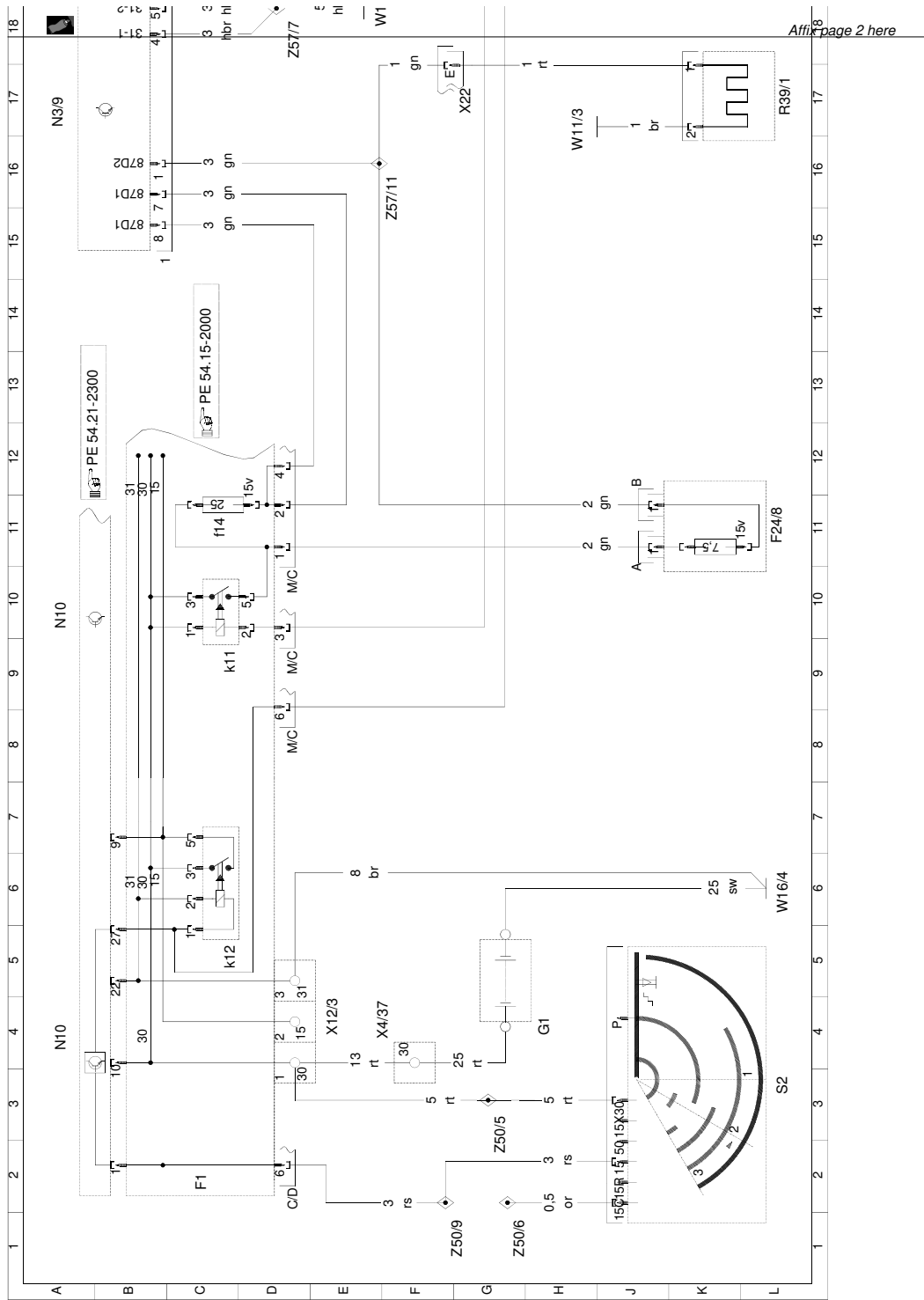

Wiring diagram of common rail diesel injection (CDI) control module / pe07.16-p-2000-99gh  
ENGINE 612 in MODEL 163 up to 31.8.01 Engine block wiring harnesses / Printed on: 07.12.2019 / Page 1/4

## D. W163 ML270 CDI wiring diagram for reference (OM612 engine)

---

**Document number:** pe07.16-p-2000-99go  
**Document title:** Wiring diagram of common rail diesel injection (CDI) control unit

<b>Code:</b>	<b>Designation:</b>	<b>Coordinates:</b>
B37	Accelerator pedal sensor	43 L
F1	Fuse and relay module	1 C
F1	Fuse and relay module	26 L
F1f14	Fuse 14	12 C
F1k11	Diesel voltage supply relay	10 C
F1k12	Circuit 15 relay	5 C
F24/7	Circuit 30 auxiliary fuse, suction fan	40 G
F24/8	Circuit 15 auxiliary fuse	12 L
G1	Battery	4 H
G1	Battery	39 F
M4/7	Electric suction fan engine and AC with integrated control	38 L
N10	All-activity module	4 A
N10	All-activity module	11 A
N10/1	Extended Activity module (EAM)	50 A
N2/7	Restraint systems control module	31 L
N3/9	CDI control module	18 A
N3/9	CDI control module	28 A
N3/9	CDI control module	39 A
S16/6	Kickdown switch	27 L
S2	Starter switch	3 L
S40/3	Clutch pedal switch	7 L
S40/4	CC with variable speed limiter switch	50 L
S40/4s1	Resume from memory	47 J
S40/4s2	Decelerate and set	51 J
S40/4s3	Accelerate and set	50 J
S40/4s4	Off	47 J
S40/4s5	Control contact	50 J
S40/4s6	Variable speed	51 K
S40/4v1	Yellow LED, variable speed limiter	51 K
U24	Valid for MT [MG]	6 E
W16/4	Ground (output ground - component compartment - right)	5 L
W16/4	Ground (output ground - component compartment - right)	40 C
W16/5	Electronics ground (left of component compartment)	19 F
W2	Ground (at right headlamp unit)	39 C
W29/2	Ground (right A-pillar)	7 F
X12/12	Circuit 30 terminal block at relay module 1	2 E
X12/13	Circuit 15 terminal block at relay module 1	4 E
X12/14	Circuit 31 terminal block at relay module 1	5 E
X25/2	Engine compartment/interior compartment connector	25 G



## D. W163 ML270 CDI wiring diagram for reference (OM612 engine)

---

**Document number:** pe07.16-p-2000-99go  
**Document title:** Wiring diagram of common rail diesel injection (CDI) control unit

<b>Code:</b>	<b>Designation:</b>	<b>Coordinates:</b>
X26	Engine compartment/cockpit connector	22 F
X4/37	Terminal block (circuit 30)	4 F
Z37/2	CAN engine bus (low) connector sleeve	32 D
Z37/3	CAN engine bus (high) connector sleeve	32 D
Z50/11	CAN-L cockpit connector sleeve	53 D
Z50/12	CAN-H cockpit connector sleeve	52 D
Z50/3	Cockpit connector sleeve (circuit 31, I left)	51 F
Z50/4	Cockpit connector sleeve (circuit 31, II right)	6 H
Z50/5	Cockpit circuit 30 connector sleeve	2 G
Z50/6	Cockpit connector sleeve (circuit 15C)	1 H
Z50/9	Cockpit connector sleeve (circuit 15 II)	1 F
Z51/14	Interior connector sleeve, analog crash signal	30 J
Z51/3	Interior connector sleeve (CAN-High 2)	33 J
Z51/4	Interior connector sleeve (CAN-Low 2)	32 J
Z51/8	Interior connector sleeve II (circuit 31, right front)	27 H
Z57/11	Right engine compartment, circuit 15 connector sleeve	17 F
Z57/7	Right engine compartment connector sleeve, circuit 31 (3)	18 E

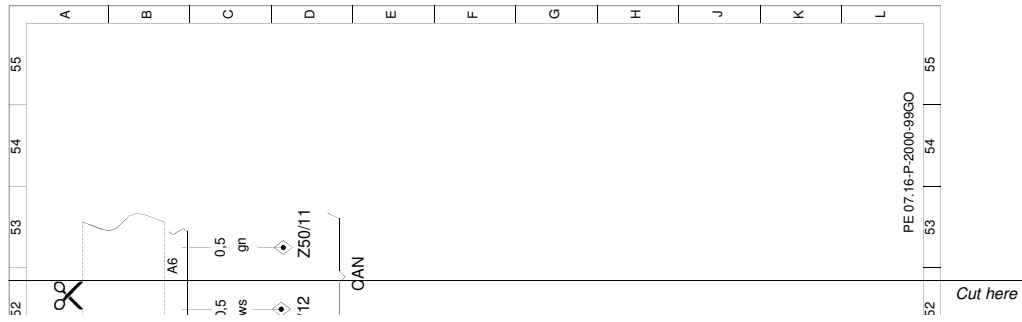

Wiring diagram of common rail diesel injection (CDI) control unit / pe07.16-p-2000-99go  
ENGINE 612 in MODEL 163 as of 1.9.02 / Printed on: 07.12.2019 / Page 4/4

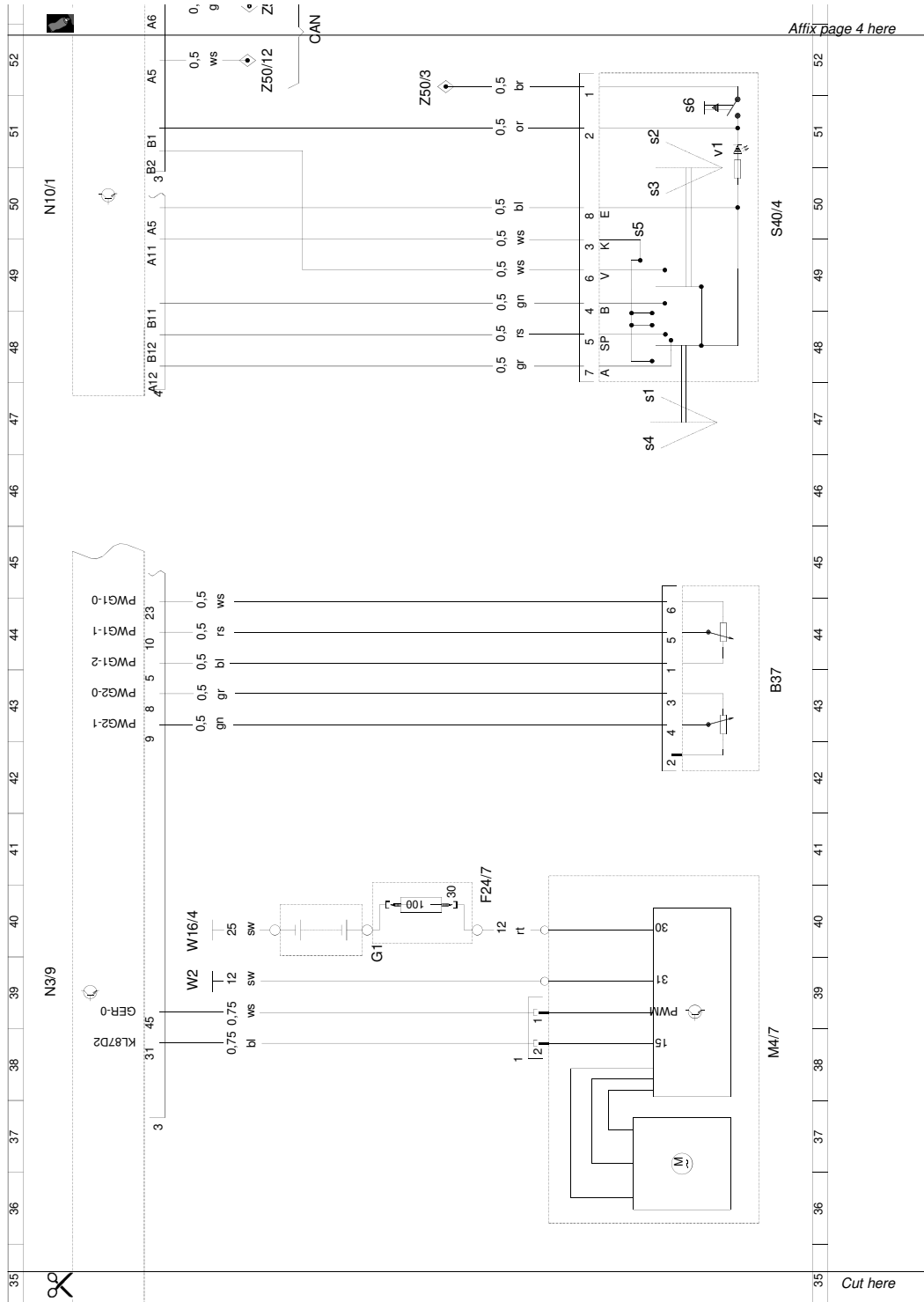

Wiring diagram of common rail diesel injection (CDI) control unit / pe07.16-p-2000-99go  
ENGINE 612 in MODEL 163 as of 1.9.02 / Printed on: 07.12.2019 / Page 3/4

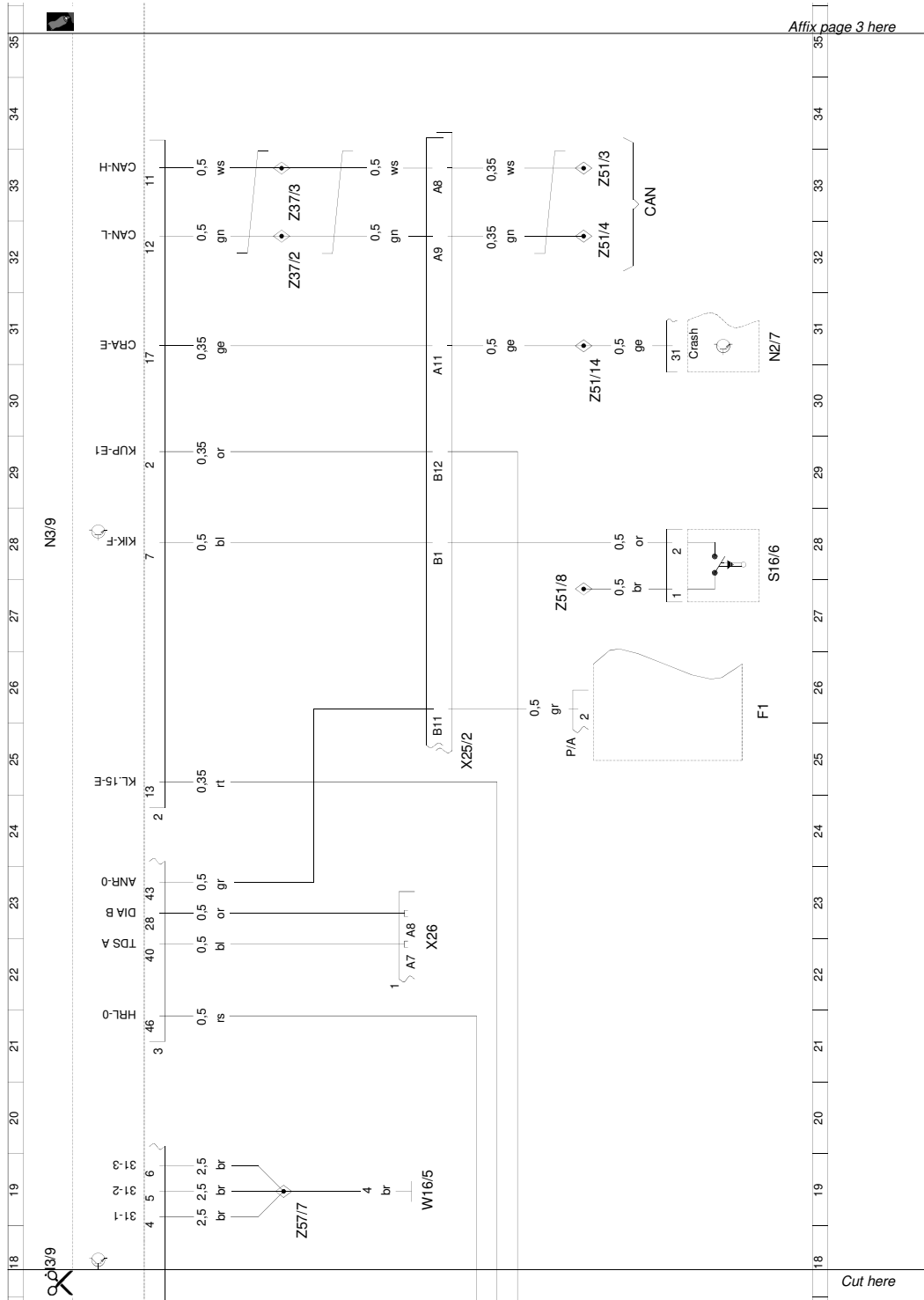

Wiring diagram of common rail diesel injection (CDI) control unit / pe07.16-p-2000-99go  
ENGINE 612 in MODEL 163 as of 1.9.02 / Printed on: 07.12.2019 / Page 2/4

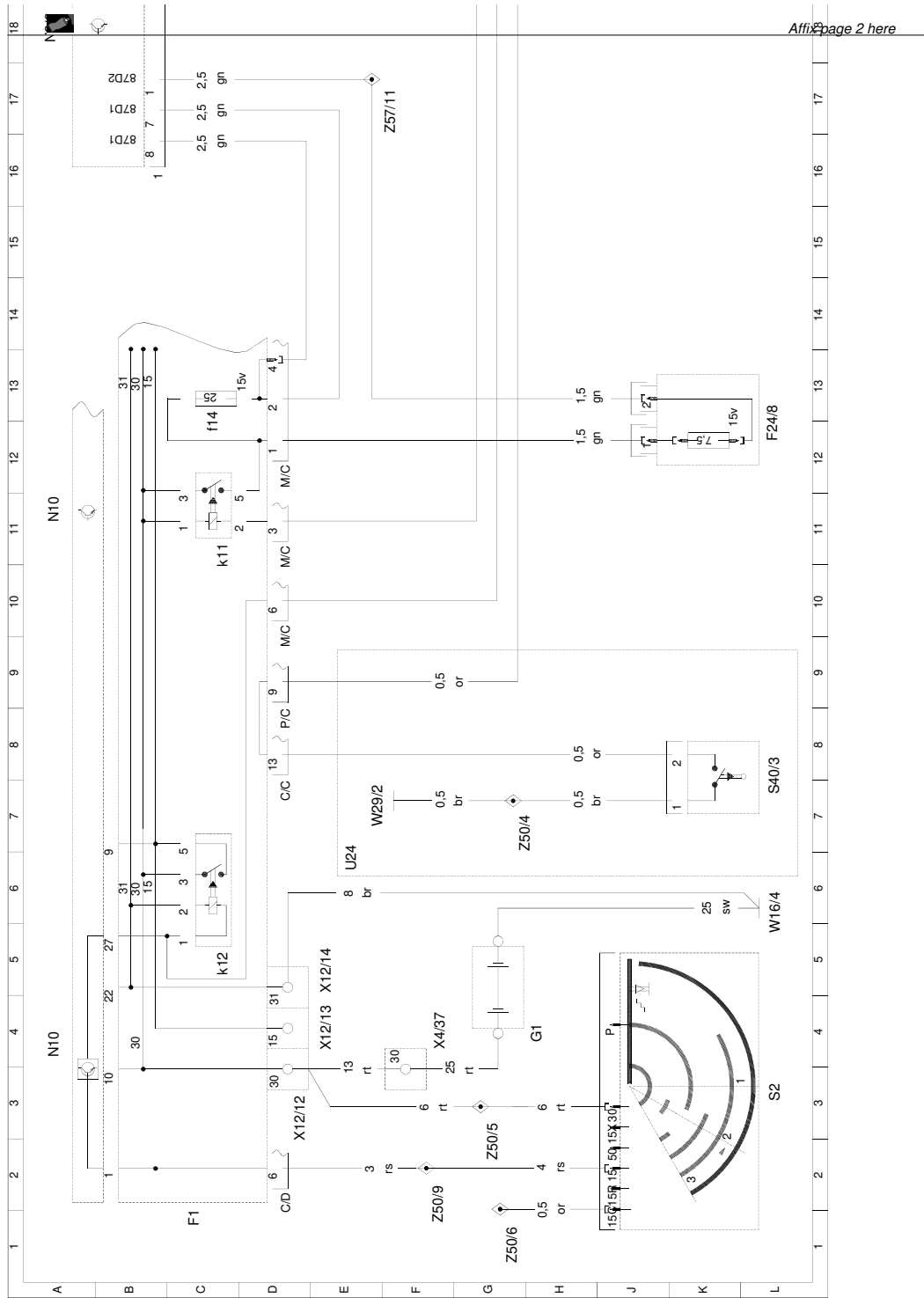

Wiring diagram of common rail diesel injection (CDI) control unit / pe07.16-p-2000-99go  
ENGINE 612 in MODEL 163 as of 1.9.02 / Printed on: 07.12.2019 / Page 1/4

## E Mercedes Benz OM648 wiring

The following diagram shows the factory wiring of the OM648 engine as fitted to W211 E320 CDI cars. This chapter contains wiring guidelines for this engine when fitting to the DID1 ECU.

Engine devices:

### Injector 1 (Y76y1)

Device pin	Wire colour	Function	OEM pin	DID1 pin
1	black/blue	Negative	1/49	5/5
2	blue	Positive	1/2	5/4

### Injector 2 (Y76y2)

Device pin	Wire colour	Function	OEM pin	DID1 pin
1	black/violet	Negative	1/50	5/8
2	blue/violet	Positive	1/3	5/4

### Injector 3 (Y76y3)

Device pin	Wire colour	Function	OEM pin	DID1 pin
1	black/red	Negative	1/73	5/7
2	blue/red	Positive	1/1	5/4

### Injector 4 (Y76y4)

Device pin	Wire colour	Function	OEM pin	DID1 pin
1	black/yellow	Negative	1/75	5/6
2	blue/yellow	Positive	1/27	5/4

### Injector 5 (Y76y5)

Device pin	Wire colour	Function	OEM pin	DID1 pin
1	black/green	Negative	1/74	5/9
2	blue/green	Positive	1/25	5/4

### Injector 6 (Y76y6)

Device pin	Wire colour	Function	OEM pin	DID1 pin
1	black/white	Negative	1/51	5/3
2	blue/white	Positive	1/26	5/4

### Volume control valve (Y94) Connects to output 4

Device pin	Wire colour	Function	OEM pin	DID1 pin
1	yellow/black	+12V	1/76	3/37
2	black/yellow	Negative	1/28	3/50

**Oil level sensor (B40)** Not currently supported.

**Vent line heater (R39/1)** Not ECU controlled. Wire to switched 12V supply or omit.

**Fuel temperature sensor (B50)** Optional. Skip or connect to analog input with 3k pull up.

Device pin	Wire colour	Function	OEM pin	DID1 pin
1	blue/green	return	1/32	3/19
2	black/yellow	signal	1/8	3/16

**Crank position sensor (L5)**

Device pin	Wire colour	Function	OEM pin	DID1 pin
1	green	signal	1/87	4/26
2	green/white	return	1/88	4/37

**Pressure regulator valve (Y74)** Connects to output 3

Device pin	Wire colour	Function	OEM pin	DID1 pin
1	yellow/black	+12V	1/4	4/21
2	black/yellow	Negative	1/52	4/31

**Rail pressure sensor (B4/6)** Connects to analog in 4

Device pin	Wire colour	Function	OEM pin	DID1 pin
1	grey/brown	return	1/84	4/4
2	green/violet	signal	1/59	4/14
3	red/white	+5V supply	1/86	4/13

**Pressure sensor downstream of air cleaner (B28/5)** Not necessary, connect to any analog input or omit.

**Mass airflow sensor (B2/5)** Not necessary, connect to any analog input or omit.

**Exhaust back pressure sensor (B60)** Not necessary, connect to any analog input or omit.

**DPF differential pressure sensor (B28/8)** Not necessary, connect to any analog input or omit.

**Upstream TWC temperature sensor (B19/7)** Not supported.

**Downstream TWC temperature sensor (B19/8)** Not supported.

**Inlet port shutoff motor (M55)** Not currently supported, support planned.

**Throttle valve actuator (M16/5)** Not supported.

**O2 sensor upstream (G3/3)** Not supported.

**Exhaust gas recirculation valve (Y27/9)** Not currently supported, support planned.

**MAP sensor/charge pressure sensor (B5/1)** Connects to analog in 6

Device pin	Wire colour	Function	OEM pin	DID1 pin
1	brown/grey	return	1/83	4/7
2	black/yellow	signal	1/63	4/6
3	red/black	+5V supply	1/60	4/8

**Camshaft position sensor (B6/1)**

Device pin	Wire colour	Function	OEM pin	DID1 pin
1	brown/green	return	1/14	4/2
2	yellow/grey	signal	1/38	4/3
3	red/violet	+5V supply	1/37	4/12

**Coolant temperature sensor (B11/4)** Connects to analog in 2

Device pin	Wire colour	Function	OEM pin	DID1 pin
1	brown/red	signal	1/56	4/36
2	green/red	return	1/57	4/27

**Charge air temperature sensor (B17/8)** Connects to analog in 3

Device pin	Wire colour	Function	OEM pin	DID1 pin
1	brown/violet	signal	1/65	4/23
2	green/white	return	1/34	4/27

**Turbocharger VGT actuator (B100/1)** Also known as charge air positioner. Not currently supported but support planned very soon.

Device pin	Wire colour	Function	OEM pin	DID1 pin
1	red/black	+12V supply	1/70	4/25
2	brown/blue	ground	1/44	Ground
4	grey/green	LIN bus	1/93	4/32



**Document number:** pe07.16-p-2101-99dd  
**Document title:** Wiring diagram for common rail diesel injection (CDI) control unit

<b>Code:</b>	<b>Designation:</b>	<b>Coordinates:</b>
A0	Explanation of color codes	64 L
B11/4	Coolant temperature sensor	48 L
B17/8	Charge air temperature sensor	50 L
B19/7	Upstream TWC [KAT] temperature sensor	28 L
B19/8	Downstream TWC [KAT] temperature sensor	29 L
B2/5	Hot film MAF sensor	21 L
B2/5b1	Intake air temperature sensor	22 L
B28/5	Pressure sensor downstream of air cleaner	19 L
B28/8	Pressure differential sensor (DPF)	27 L
B4/6	Rail pressure sensor	17 L
B40	Oil sensor (oil level, temperature and quality)	11 L
B5/1	Charge pressure sensor	45 L
B50	Fuel temperature sensor	13 L
B6/1	Camshaft Hall sensor	47 L
B60	Exhaust back pressure sensor	24 L
G3/2	O2 sensor 1 upstream TWC [KAT]	36 L
G3/2x1	O2 sensor upstream TWC [KAT] connector	34 K
L5	Crankshaft position sensor	15 L
M16/5	Throttle valve actuator	33 L
M55	Inlet port shutoff motor	31 L
N10/1	Driver-side SAM control module with fuse and relay module	39 L
N3/9	CDI control module	4 A
N3/9	CDI control module	11 A
N3/9	CDI control module	20 A
N3/9	CDI control module	28 A
N3/9	CDI control module	34 A
N3/9	CDI control module	44 A
N3/9	CDI control module	53 A
N3/9	CDI control module	58 A
R39/1	Vent line heater element	12 L
U704	Valid for EURO 4 and USA emissions standards	24 A
W15/3	Ground (electronics)	58 L
X22	Engine compartment and engine connector	57 H
Y100/1	Right charge pressure positioner	52 L
Y100/1	Right charge pressure positioner	55 L
Y27/9	Left exhaust gas recirculation positioner	43 L
Y74	Pressure regulator valve	16 L
Y76	Fuel injectors	3 L
Y76y1	Fuel injector (1st cylinder)	1 L

**Document number:** pe07.16-p-2101-99dd  
**Document title:** Wiring diagram for common rail diesel injection (CDI) control unit

<b>Code:</b>	<b>Designation:</b>	<b>Coordinates:</b>
Y76y2	Fuel injector (2nd cylinder)	3 L
Y76y3	Fuel injector (3rd cylinder)	4 L
Y76y4	Fuel injector (4th cylinder)	5 L
Y76y5	Fuel injector cylinder 5	7 L
Y76y6	Fuel injector cylinder 6	8 L
Y94	Volume control valve	9 L
Z3/4	Circuit 30 connector sleeve	32 H
Z3/4	Circuit 30 connector sleeve	41 E
Z3/4	Circuit 30 connector sleeve	55 H
Z6/1	Ground connector sleeve	33 G
Z6/1	Ground connector sleeve	43 E
Z6/1	Ground connector sleeve	56 H



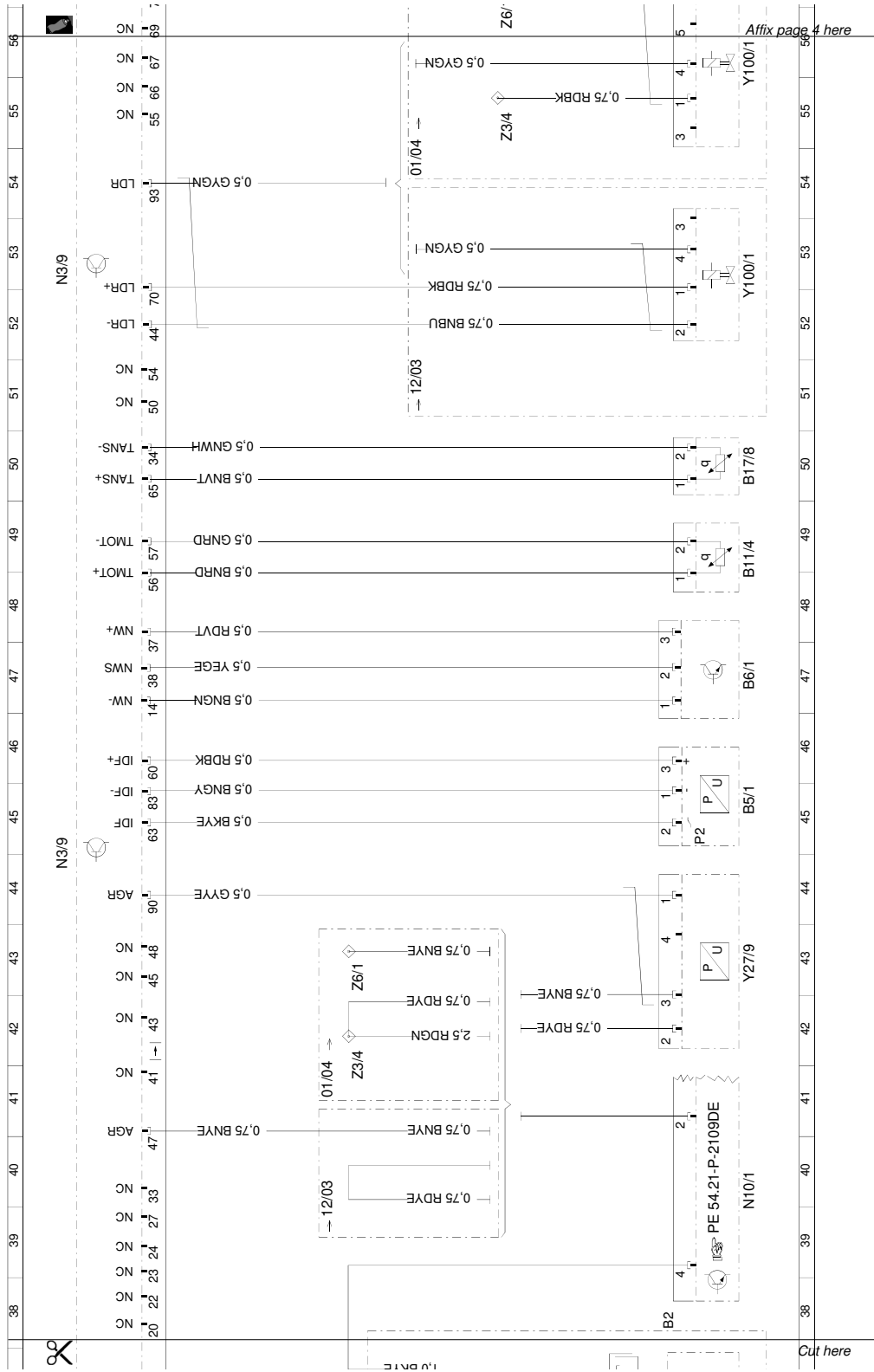

Wiring diagram for common rail diesel injection (CDI) control unit / pe07.16-p-2101-99dd  
 ENGINE 648 up to 31.5.05 in MODEL 211 Steuergerät N3/9, Blatt 2 / Printed on: 02.01.2020 / Page 3/4

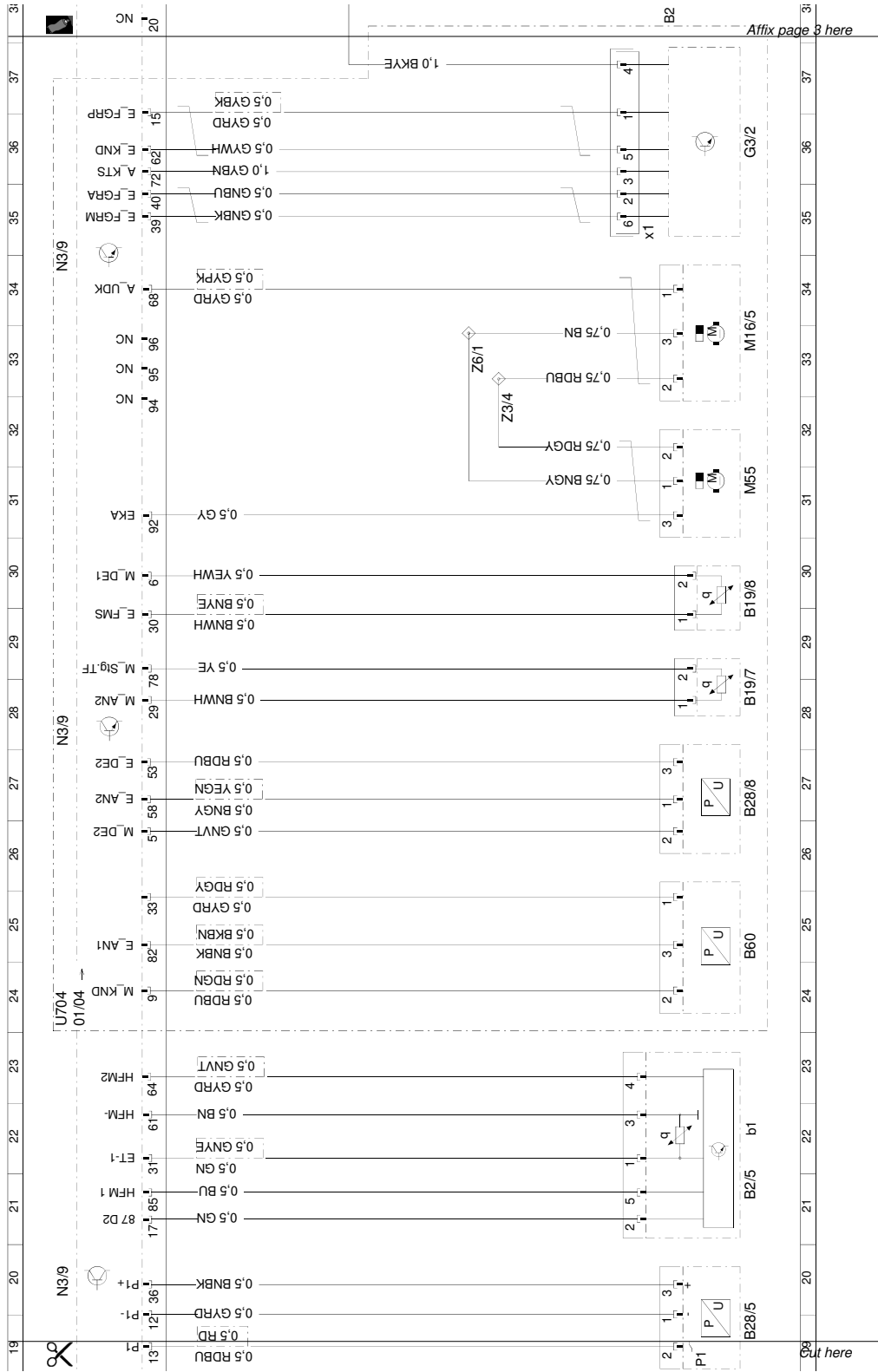

Affix page 8 here

Cut here

Wiring diagram for common rail diesel injection (CDI) control unit / pe07.16-p-2101-99dd  
 ENGINE 648 up to 31.5.05 in MODEL 211 Steuergerät N3/9, Blatt 2 / Printed on: 02.01.2020 / Page 2/4

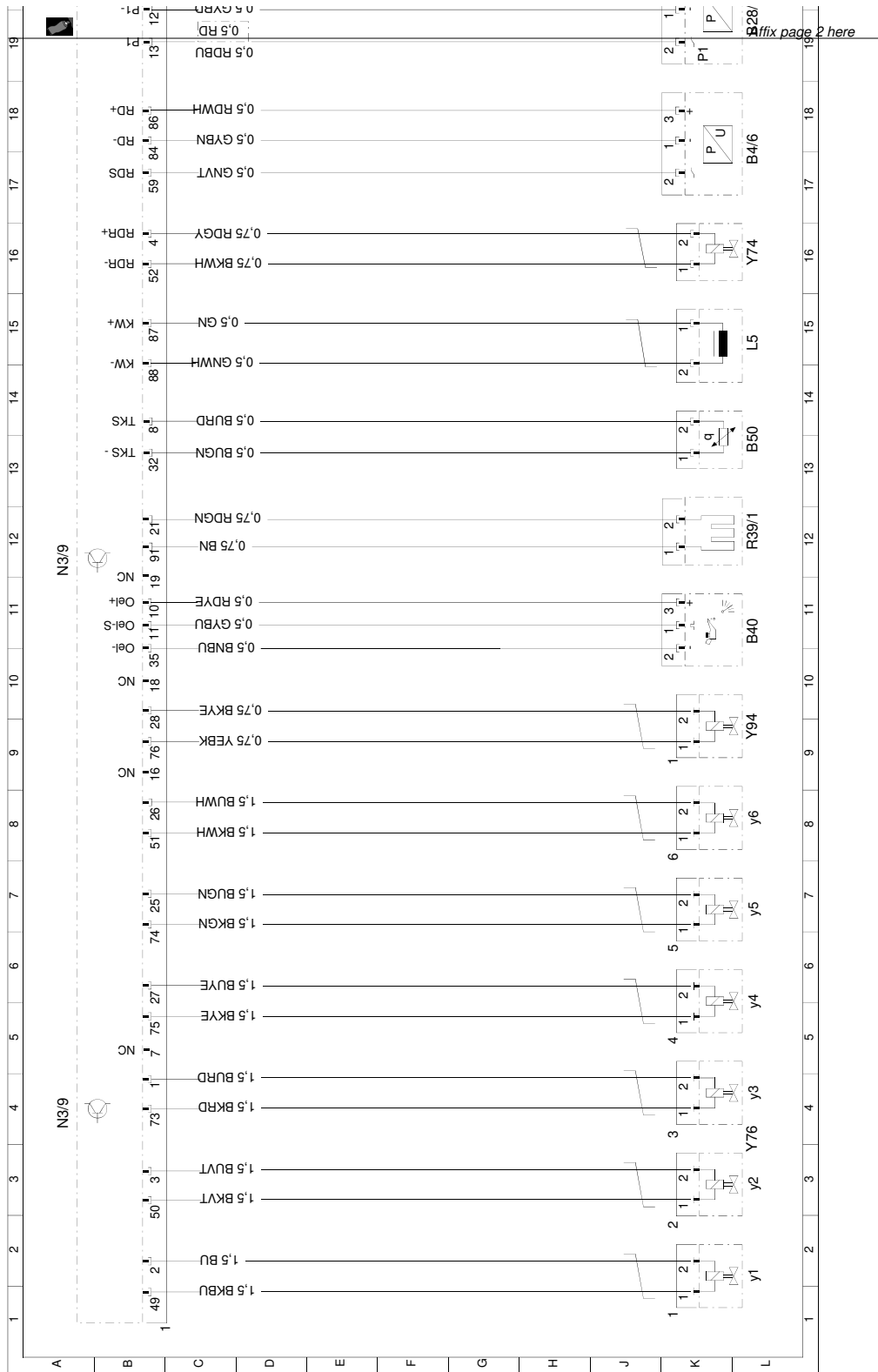

Wiring diagram for common rail diesel injection (CDI) control unit / pe07.16-p-2101-99dd  
ENGINE 648 up to 31.5.05 in MODEL 211 Steuergerät N3/9, Blatt 2' / Printed on: 02.01.2020 / Page 1/4